

SATELLAR DIGITAL SYSTEM  
PART III: RADIO UNIT  
SATELLAR XT 5R AND XT 5RC  
USER GUIDE VERSION. 1.7

RU

USER GUIDE

# **SATEL**

Copyright © 2018 SATEL Oy

No part of this document may be reproduced, transmitted or stored in a retrieval system in any form or by any means without the prior written permission of SATEL Oy. This document is provided in confidence and must not be distributed to third parties without the express permission of SATEL Oy.

# Contents

Important notice	6
Restrictions on use	7
Product conformity	8
Warranty and safety instructions	9
1. Introduction to the SATELLAR product family	10
1.1 Mounting	14
1.2 Terms and abbreviations	14
2. Technical specifications	15
3. Typical setup	19
4. Mounting	21
4.1 Mounting of the SATELLAR XT 5R and 5RC	21
4.2 Front cover	22
5. Interfaces	23
5.1 Serial data	24

5.1.1	RS-232	24
5.1.2	RS-485/422 interface	25
5.1.3	RS-485/422 line length	26
5.1.4	Unit load	26
5.1.5	RS-485/422 termination	26
5.1.6	RS-485/422 connection/termination examples	26
5.1.7	Failsafe RS-485/422 termination	28
5.2	Radio	29
5.3	DC supply	30
5.4	Diagnostics, monitoring, changing settings	30
5.5	LED indicators	31
5.6	Function button	32
<b>6.</b>	<b>Data transmission</b>	<b>35</b>
6.1	Basic mode with TX priority	35
6.2	Basic mode with RX priority	37
6.3	Basic mode with repeater	38
6.4	Source routing	38
6.5	Packet routing	41
6.5.1	Radio access control	43
6.6	Data flow control in basic and source routing mode	44
6.6.1	TX delay	44
6.6.2	Handshaking	44
6.6.3	Error control	46
6.6.4	Pause length	46

7.	Settings	47
7.1	Network protocol modes	47
7.1.1	Station addresses and network ID	48
7.2	Radio settings	49
7.3	Serial connector configuration	50
7.4	Data port settings	51
7.5	Serial data flow control	52
7.6	Packet mode radio access control	53
8.	Accessories	57
9.	SATEL open source statements	58
9.1	AES Encryption	58
10.	Troubleshooting	59
10.1	Error codes	59
10.2	Connection problems	63
11.	Settings selection guide	64
11.1	Modem Settings	64

## Important notice

3

All rights to this manual are owned solely by SATEL Oy (referred to in this user guide as SATEL). All rights reserved. The copying of this manual (without written permission from the owner) by printing, copying, recording or by any other means, or the full or partial translation of the manual to any other language, including all programming languages, using any electrical, mechanical, magnetic, optical, manual or other methods or devices is forbidden.

SATEL reserves the right to change the technical specifications or functions of its products, or to discontinue the manufacture of any of its products or to discontinue the support of any of its products, without any written announcement and urges its customers to ensure that the information at their disposal is valid.

SATEL software and programs are delivered "as is". The manufacturer does not grant any kind of warranty including guarantees on suitability and applicability to a certain application. Under no cir-

cumstances is the manufacturer or the developer of a program responsible for any possible damages caused by the use of a program. The names of the programs as well as all copyrights relating to the programs are the sole property of SATEL. Any transfer, licensing to a third party, leasing, renting, transportation, copying, editing, translating, modifying into another programming language or reverse engineering for any intent is forbidden without the written consent of Satel.

SATEL PRODUCTS HAVE NOT BEEN DESIGNED, INTENDED NOR INSPECTED TO BE USED IN ANY LIFE SUPPORT - RELATED DEVICE OR SYSTEM - RELATED FUNCTION NOR AS A PART OF ANY OTHER CRITICAL SYSTEM AND ARE GRANTED NO FUNCTIONAL WARRANTY IF THEY ARE USED IN ANY OF THE APPLICATIONS MENTIONED.

Salo, Finland 2018

## Restrictions on use

SATELLAR radio modem has been designed to operate on 360-485 MHz, the exact use of which differs from one region and/or country to another. The user of a radio modem must take care that the said device is not operated without the permission of the local authorities on frequencies other than those specifically reserved and intended for use without a specific permit.

SATELLAR is allowed to be used in the following countries, either on licence free channels or on channels where the operation requires a licence. More detailed information is available at the local frequency management authority.

Countries: AT, BE, BG, CH, CY, CZ, DE, DK, EE, ES, FI, FR, GB, GR, HR, HU, IE, IL, IT, LV, LT, LX, MT, NL, NO, PL, PT, RO, RU, SE, SI and SK.

# Product conformity

## SATELLAR

SATEL Oy hereby declares that SATELLAR Radio Unit (referred to in this user guide as RU) radio modem is in compliance with the essential requirements (radio performance, electromagnetic compatibility and electrical safety) and other relevant provisions of Directive 2014/53/EU. Therefore the equipment is labelled with the following CE-marking.

3



# Warranty and safety instructions

Read these safety instructions carefully before using the product:

- The warranty will be void if the product is used in any way that is in contradiction with the instructions given in this manual, or if the housing of the radio modem has been opened or tampered with.
- The radio modem is only to be operated at frequencies allocated by local authorities, and without exceeding the given maximum allowed output power ratings. Satel and its distributors are not responsible if any products manufactured by it are used in unlawful ways.
- The devices mentioned in this manual are to be used only according to the instructions described in this manual. Faultless and safe operation of the devices can be guaranteed only if the transport, storage, operation and handling of the devices is appropriate. This also applies to the maintenance of the products.
- To prevent damage to device, both the radio modem and any terminal device must always be switched OFF before connecting or disconnecting the serial connection cable. It should be ascertained that different devices used have the same ground potential. Before connecting any power cables the output voltage of the power supply should be checked.
- It is possible to connect the device to an outdoor antenna or a cable distribution system. In these cases, in order to conduct the possible over voltages due to lightnings to earth, the equipment should be connected to protective earth by using the mounting screws of the device. This is a requirement in order to be in compliance with the electrical safety regulations (EN 60950-1).
- To be protected against all verified adverse effects the separation distance of at least 50 cm must be maintained between the antenna of SATELLAR radio modem and all persons.
- Any radio link can susceptible to external interference and signal degradation by its nature. Beacuse of that, the effects of possible interference mechanism and the sufficient back-up schemes must be taken into account in the system design of the critical applications.

# 1. Introduction to the SATELLAR product family

SATELLAR is a new generation narrow band radio modem, which consists of separate units:

- Central unit (CU)
- Radio unit (RU)



Figure 1.1 SATELLAR product family:

1. SATELLAR XT 5RC with display:  
Central unit (CU) with display and keypad + radio unit (RU)
2. SATELLAR XT 5RC without display:  
Central unit (CU) without display and keypad + radio unit (RU)
3. SATELLAR XT 5R: Radio unit (RU)

Using SATELLAR, customers build their own independent radio data communication network.

This document presents the specifications and the intended use of the RU. The properties of other units are described in their own manuals. Reading them is necessary to understand the operation of the RU.

## Data communication

SATELLAR operates either as a transparent radio link, essentially replacing a cable, for classic RS-232 / RS-485 / RS-422 based protocols or as a wireless router in an IP-based network. When the RU is acting as a router station in an IP network without any local Ethernet connection, it can be used as a standalone device. In stations where a local Ethernet connection is needed it must be used together with a CU.

## 1. Introduction to the SATELLAR product family



Figure 1.2 SATELLAR XT 5R: The Radio unit (RU) is used as standalone device router station, where Ethernet is not needed.



Figure 1.3 SATELLAR XT 5RC with display (on down left), SATELLAR XT 5RC without display (on down right) include RU and CU. These types are used, when a local Ethernet connection is needed.

### Range

In the RU of the SATELLAR the communication range of a point to point link is typically longer than 10 km in urban conditions (some obstacles in the line of sight), and longer than 20 km in line of sight conditions. Significantly longer range can be achieved, depending on radio conditions, antenna selection etc. The range can be further extended also by using the radio repeaters.

### Security

Data security is often a concern when using radio communication. In the SATELLAR a 128-bit encryption on the air-interface ensures privacy in the radio network. With QAM-radio also the 256-bit encryption is supported.

### Flexible and expandable

The SATELLAR concept has been designed to be flexible and expandable both in terms of hardware and software functions. This can also be seen when using the RU alone.

### Modulation method

There are two - different kind - of radio units, one that support FSK modulation and one that supports QAM modulation. Apart from the modulation and channel separation both of the different radio units operate similarly and possible differences are described in this user guide. These two versions are called FSK-radio and QAM-radio throughout this document. Several different modulation levels are offered for both of these variants. If the customer requires a long-range radio connection he/she selects a low level modulation. On the contrary, if a high data rate is the primary concern a high level modulation must be selected.

### Channel width

Channel spacings 12.5, 25 and 150 kHz are supported with FSK-radio and with QAM-radio unit supported channel spacings are 6.25, 12.5 and 25 kHz. Those can be selected by changing software settings – without a need to modify the hardware.

### FEC (Forward Error Correction) and interleaving

To extend the radio range in a noisy environment (at the expense of the data rate) a forward error correction algorithm (FEC) can be used with FSK-radio. The RU offers two different code rates for forward error correction and it is used together with interleaving to minimize the effect of errors occurring in bursts.

### Adjustable output power

RF output power is adjustable within steps defined at factory by manufacturer. Maximum factory set output power can not be exceeded by customer.

**NOTE:** It should be noted that modulation, channel spacing, and FEC must be equal in the whole network.

## 1. Introduction to the SATELLAR product family

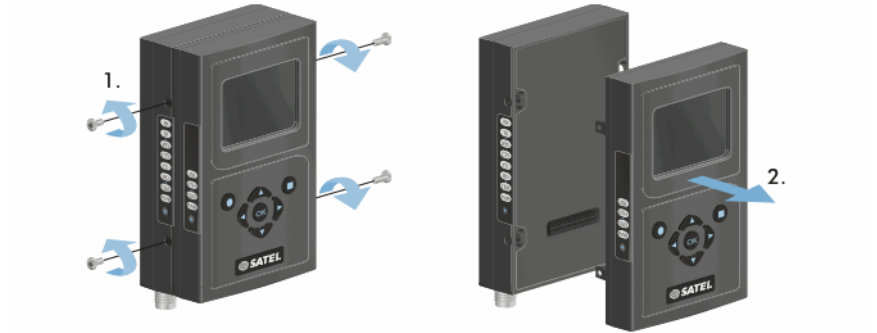

Figure 1.4 Modular construction, mounting of the central unit CU

## 1.1 Mounting

SATELLAR can be mounted directly on a flat surface or to a DIN rail. DIN-rail mounting is possible either on the backside of the stack of different SATELLAR units or on the other narrow side of each unit (the latter case so that the LED indicators remain visible for the user). See chapter 4.

### Ruggedized

SATELLAR is constructed of die-cast aluminum to withstand the abuse typical to rough industrial environments. It operates over a wide temperature range and under severe vibration conditions to meet the requirements of vehicular and process industry applications.

## 1.2 Terms and abbreviations

Here below are explained a few terms and abbreviations to help the reader of this manual in understanding the basic concepts of SATELLAR.

Abbreviation	Full Name	Description
NMS	Network Management System	SATEL NMS is a combination of features and firmware running in SATEL modems, a communication protocol and external software, together allowing the monitoring, management and administration of radio modem networks consisting of SATEL devices.
SATBUS	SATEL Serial Bus	Bus used to interconnect different SATELLAR units, e.g. the RU and CU.
FPGA	Field Programmable Gate Array	Supervises the board HW and operates as a gateway between SATBUS and the MCU.
MCU	Master Controller Unit	Main processor of the RU, responsible for DATA handling and control of the unit electronics.
DSP	Digital Signal Processor	Performs digital signal processing and radio channel medium access tasks. Issues control commands and monitor the operation of the radio part.
UART	Universal Asynchronous Receive Transmit	In standard use in SATELLAR.

Table 1.1 Terms and abbreviations

## 2. Technical specifications

### Common radio parameters

Frequency range	360 – 485 MHz (Ask the availability from manufacturer)
Tuning range MHz	45 (360 - 405/400 - 445/440 - 485 MHz)
Channel width	FSK-radio: 12,5, 25, 150 kHz selectable by software QAM-radio: 6.25, 12,5, 25 kHz selectable by software
Carrier frequency setting	Frequency programmability in 6.25 kHz steps
Carrier frequency accuracy (over temperature)	+/-2.5 ppm
Carrier frequency long term stability	+/-2.0 ppm/3 years
Latency (in transparent mode) (25 kHz, serial port speed 19200 bits/s, over-the-air encryption off, FEC off)	< 18 ms
Modulation methods	FSK-radio: 4-, 8- and 16-FSK QAM-radio: 2-, 4-, 8-, 16-, 32- and 64-QAM
Forward error correction (FEC)	Off, code rate 0.67, code rate 0.5 NOTE! FEC not available with 16-FSK or with QAM modulation
Trellis coding	Supported for 8-, 16-, 32- and 64-QAM modulation
Interleaving	8 x 96 bits
Over-the-air encryption	FSK-radio: AES 128 bit (CTR-mode) QAM-radio: AES 128 / 256 bit (CTR-mode)

### Transmitter parameters

Output power	
FSK-radio unit	0.1...5 W adjustable by software, Steps: 0.1, 0.2, 0.5, 1, 2, 5 W
QAM-radio unit	0.1...5 W adjustable by software, Steps: 0.1, 0.2, 0.5, 1, 2, 5 W (peak power ratings due to QAM modulation). Average power at max peak power level is ~1W.
Adjacent channel power:	Typically < -63 dBc (meas. method EN 300 113/EN 301 166)

Air speed	bits/s @12.5 kHz	bits/s @ 25 kHz	bit/s @ 150 kHz
	4-FSK	9600	19200
8-FSK	14400	28800	172800
16-FSK	19200	38400	230400
	bits/s @6.25 kHz	bits/s @12.5 kHz	bits/s @25 kHz
	2-QAM	4680	10080
4-QAM	9360	20160	40320
8-QAM	14040	30240	60480
16-QAM	18720	40320	80640
32-QAM	23400	50400	100800
64-QAM	28080	60480	120960

### Receiver parameters / FSK-radio

Channel spacing / modulation	Sensitivity / dBm		
	BER		
	10E-3	10E-6	SNR* (minimum)
25 kHz / 19200 bps (4-FSK)	-116	-108	20
12.5 kHz / 9600 bps (4-FSK)	-119	-114	20
150 kHz / 115200 bps (4-FSK)	-104	-97	20
25 kHz / 28800 bps (8-FSK)	-108	-102	26
12.5 kHz / 14400 bps (8-FSK)	-112	-105	26
150 kHz / 172800 bps (8-FSK)	-96	-89	26
25 kHz / 38400 bps (16-FSK)	-102	-94	32
12.5 kHz / 19200 bps (16-FSK)	-104	-97	32
150 kHz / 230400 bps (16-FSK)	-88	-82	32

## 2. Technical specifications

### Receiver parameters / QAM-radio

#### Sensitivity / dBm

Channel spacing / modulation	BER		
	10E-3	10E-6	SNR* (minimum)
6.25 kHz / 4680 bps (2-QAM)	-121	-118	11
12.5 kHz / 10080 bps (2-QAM)	-118	-116	11
25 kHz / 20160 bps (2-QAM)	-117	-114	11
6.25 kHz / 9360 bps (4-QAM)	-118	-115	14
12.5 kHz / 20160 bps (4-QAM)	-115	-113	14
25 kHz / 40320 bps (4-QAM)	-114	-111	14
6.25 kHz / 14040 bps (8-QAM)	-115	-112	17
12.5 kHz / 30240 bps (8-QAM)	-113	-109	17
25 kHz / 60480 bps (8-QAM)	-111	-108	17
6.25 kHz / 18720 bps (16-QAM)	-111	-109	20
12.5 kHz / 40320 bps (16-QAM)	-110	-106	20
25 kHz / 80640 bps (16-QAM)	-108	-105	20
6.25 kHz / 23400 bps (32-QAM)	-108	-106	23
12.5 kHz / 50400 bps (32-QAM)	-107	-103	23
25 kHz / 100800 bps (32-QAM)	-105	-102	23
6.25 kHz / 28080 bps (64-QAM)	-105	-102	27
12.5 kHz / 60480 bps (64-QAM)	-104	-100	27
25 kHz / 120960 bps (64-QAM)	-101	-98	27

\* SNR = Detector Signal to Noise Ratio

### Common parameters

#### Power consumption

SATELLAR radio unit	17.9 W, 5 W transmission (TX mode)
	7.3 W, 100 mW transmission (TX mode)
	2.8 W, reception (RX mode)
Start time (from power off)	< 2,5 s
Interfaces – power	2-pin plug with screw flange, pitch 3.5 mm, type Phoenix Contact MC 1,5/2-GF-3,5 THT, code 1937318
Interfaces – DTE	RS-232/422/485 (TIA-574), D9 female
	Up to 57,6 kbps
Interfaces – RF	TNC female, 50 ohm

Temperature ranges	-25 - +55 °C, complies with the standards
	-30 - +75 °C, functional
	-40 - +85 °C, storage
Humidity	< 95 % @ 25 °C, non-condensing
Vibration	At least 10 – 500 Hz/5g without degradation in data transfer capability
Shock resistivity	Dropping height 1 m, all directions
IP rating	IP 52
DC input range	+10.6 ... 30 V
Mechanical dimensions H × W × D	
SATELLAR radio unit	130 × 55.5 × 76.5 mm
Mounting	DIN rail (side or back) or directly on flat surface
Weight	
SATELLAR radio unit	680 g
Cooling	
SATELLAR radio unit	Convection cooling

### Standards

Radio requirements	FSK-radio: EN 300 113, EN 302 561
	QAM-radio: EN 300 113
EMC	
- radio unit	EN 301 489-1, -5
- central unit	IEC 61000-6-2, IEC 61000-6-4
Safety	EN 60950-1
RoHS	2002/95/EC, 2002/96/EU, 2011/65/EU

Table 2.1 Technical specifications of SATELLAR radio unit

## 3. Typical setup

The figure below shows a typical setup when transferring data through the RU. When using the RU together with the CU, the recommended minimum distance between antenna and the CU is 2 m in order to avoid degradation of the receiver sensitivity due to radiated interference from the CU. Setup is the same whether the radio unit used is FSK- or QAM-radio.

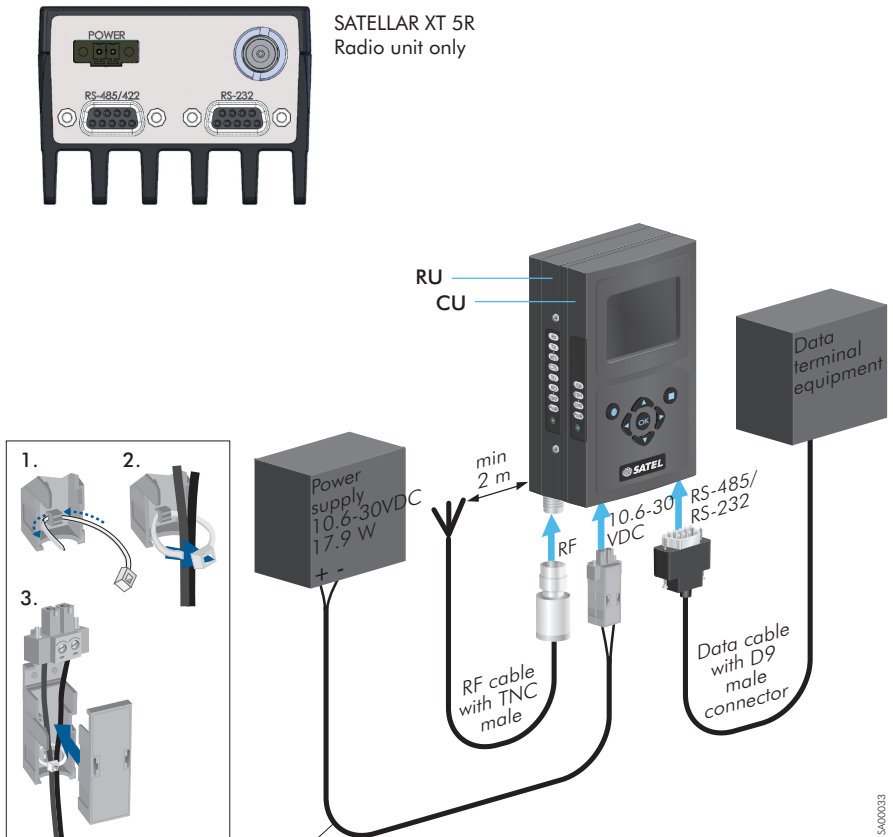

Figure 3.1 Transferring data through the RU, cabling

If the user wants to change/view settings the Data terminal equipment needs to be replaced by a PC. The role of the port must then be changed to accept NMS messages. This can be done by pressing the function button that is located below the RU LED indicators. The functionality of the button is described in chapter 5.5. When the type of the DTE interface is the standard RS-232, the port can also be configured so that it is possible to use the Data terminal equipment and PC simultaneously (see chapter 7.4 for details).

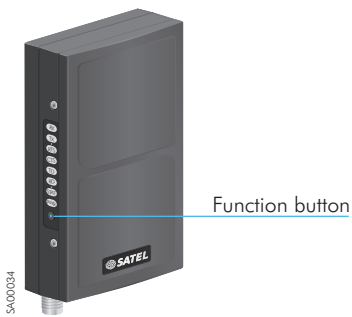

Figure 3.2 Location of the Function button

## 4. Mounting

### 4.1 Mounting of the SATELLAR XT 5R and 5RC

The SATELLAR XT 5R and 5RC can be mounted as follows:

- On a DIN-rail using SATELLAR specific DIN rail adapters (two pieces needed) connected at the other edge or at the bottom of the unit.
- With wall mount parts.
- The DIN rail adapters and wall mount parts have to be ordered separately.

Mounting is the same whether the radio unit used is FSK- or QAM-radio.

Please contact manufacturer to get more information regarding mounting of the units.

#### NOTE!

1. The equipment must be installed in restricted access location due to high touch temperatures of metal enclosure.
2. The screen of coaxial antenna cable must be grounded to protect from over voltages from outdoor antenna.

## 4.2 Front cover

When the radio unit is used as standalone it is possible to attach a front cover on the unit. See the figure.

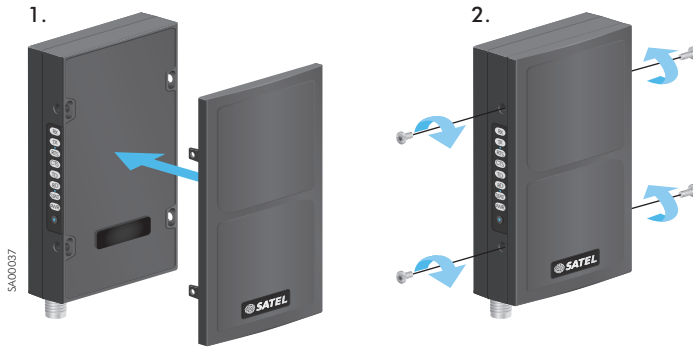

Figure 4.1 Attaching the front cover on the radio unit, when standalone.

# 5. Interfaces

This chapter describes the external interfaces of the RU how its status can be monitored, how the settings can be checked and modified. If you are using the RU attached with a CU with a display it is possible to see and change settings by the graphical user interface of the CU. With the WWW interface of the CU it is also possible to change and view the settings from a PC.

The meanings of RU related settings are described in chapter 7 of this manual.

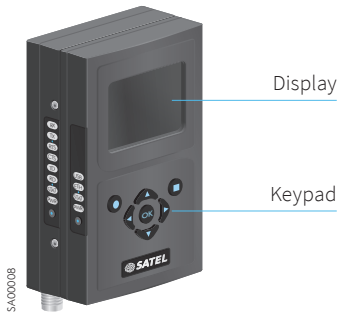

Figure 5.1 Display and keypad in CU

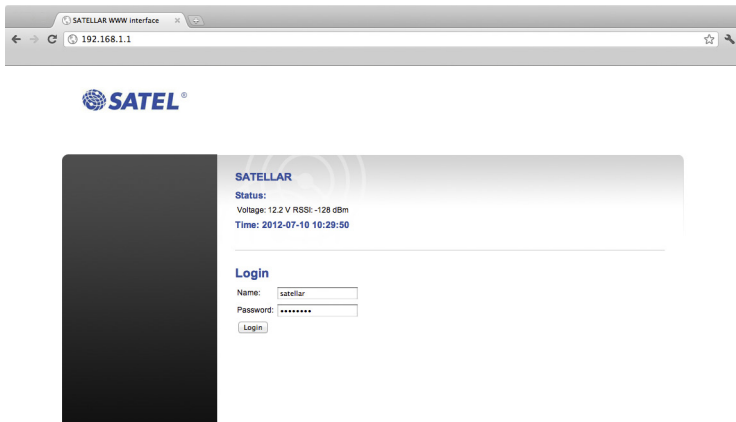

Figure 5.2 SATELLAR WWW interface Login view

## 5.1 Serial data

The RU provides two ports, both using D9 female connectors. One port is intended for RS-232 communication and hosts a full set of RS-232 signals including handshakes. The other port is intended for RS-422/485 communication via differential pair data signals. The RS-232 port can be used for data and / or NMS communication. The RS-422/485 port can be used for data only.

3

Communication settings can be done by modifying user settings. SATELLAR Y-cable is needed for simultaneous RS-232 data and NMS connections in RS-232 port.

The serial interface uses asynchronous data format.

Supported serial port speeds, QAM:

- Transparent dataflow –mode: 9600, 19200, 38400, 57600, 115200 bps
- Packet Routing –mode: 9600, 19200, 38400, 57600, 115200 bps

Supported serial port speeds, FSK:

- Transparent-, and Source Routing –mode: 1200, 2400, 4800, 9600, 19200, 38400, 57600, 115200 bps
- Packet Routing –mode: 1200\*, 2400\*, 4800\*, 9600, 19200, 38400, 57600, 115200 bps

The following additional RS port settings can be used in Packet Routing –mode (unlike Transparent-, and Source Routing –modes):

- Port Data Bits: 8
- Port Stop Bits: 1

\*) Supported only in RS232

For other data port settings, please contact SATEL technical support.

### 5.1.1 RS-232

This interface can be used as data and/or NMS interface for RU. RS-232 interface port provides standard D9 pin-out for DCE (TIA/EIA-574) as shown in the table below.

Pin nr	Pin name	Pin description
1	CD	Explained in chapter 6.6.2
2	RD	Receive Data: data traffic from the RU to the DTE
3	TD	Transmit Data: data traffic from the DTE to the RU
4	DTR	DTR function is not in use in the RU
5	SGND	Signal Ground: the common voltage reference between the DTE and the RU
6	DSR	Data Set Ready: an indication from the RU to the DTE that the RU is powered on
7	RTS	Explained in chapter 6.6.2
8	CTS	Explained in chapter 6.6.2
9	NC	Not Connected
D9 SHIELD	-	Connected to device ground

Table 5.1 RS-232, pin-out of D9 connector

## 5.1.2 RS-485/422 interface

The selection between RS-422 and 485 can be done by modifying the user settings. The RS-422/485 interface features a galvanic isolation between the interface signals and the other electronics of the RU. The interface also has a 5VDC output for external failsafe termination (see section on termination). RS-485-422 interface pin-out follows the standard for RS-485 Profibus-DP, as far as possible.

The pin-out of the D9 connector in different operating modes is shown in the table below.

Pin nr	Pin name	RS-485	RS422
		Pin description	Pin description
1	NC	-	-
2	NC	-	-
3	B	Receive/transmit data, non-inverting	Transmit data, non-inverting
4	Y	-	Receive data, non-inverting
5	SGND	Signal ground, isolated	
6	5V_TERM	Isolated 5 V for bus termination	
7	NC	-	-
8	A	Receive/transmit data, inverting	Transmit data, inverting
9	Z	-	Receive data, inverting
D9 SHIELD	-	Connected to device ground (non isolated)	

Table 5.2 RS-485/422, pin-out of D9 connector

### 5.1.3 RS-485/422 line length

The RS-485/422 specification determines the maximum theoretical line length up to 1200m. For longer line lengths dedicated repeaters should be used. Signal loss and reflections due to improper cables or improper termination may result to reduced maximum usable line length.

3

### 5.1.4 Unit load

In RS-485 specifications the RS-485 receiver input impedance is specified to be larger than or equal to 12 kOhm. This 12 kOhm impedance equals to one unit load. RS-485 specification specifies also the capability to utilize up to 32 unit loads. In this serial interface module the RS-485 receiver has 96 kOhm impedance which is 1/8 of the unit load.

This means that having bus load of 1/8 of the specified unit load (12 kOhm) allows up to 256 devices (i.e. nodes) to be connected to the bus.

Unit Load	Receiver Input Impedance	Max. No. of Nodes
1	12 kOhm	32
1/2	24 kOhm	64
1/4	48 kOhm	128
1/8	96 kOhm	256

### 5.1.5 RS-485/422 termination

For reliable operation, the RS-485/RS-422 differential pair needs to be terminated to known impedance by placing a resistor equal to the cable impedance between the two wires of the signal pair. Termination is needed to prevent waveform reflections, which can cause data errors if there are long dangling connections (stubs) in the data line.

A terminating resistor should be placed at both ends of an RS-485/422 chain. For maximum reliability, terminate at least one end of a cable using failsafe termination.

### 5.1.6 RS-485/422 connection/termination examples

Following examples represent the different general connections and terminations of RS-485 and RS-422 interfaces. Cables with twisted pair signal wiring shall be used for connections between units.

5. Interfaces

**5.1.6.1 RS-485: 2-wire connection (half duplex)**

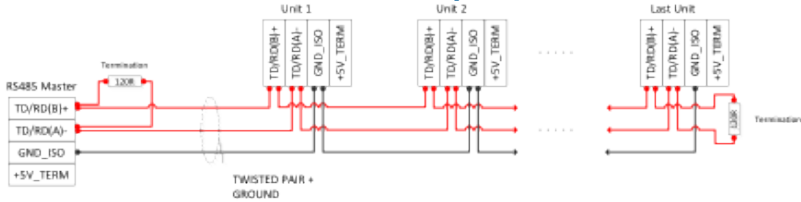

**5.1.6.2 RS-485: 4-wire connection (full duplex)**

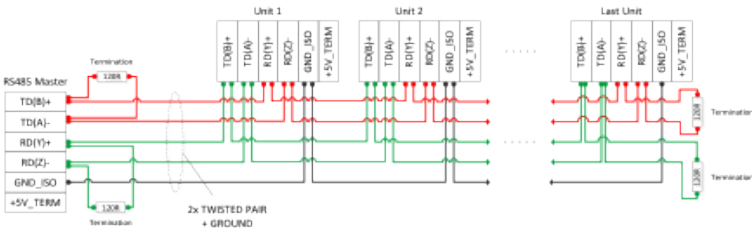

**5.1.6.3 RS-422: 2-wire connection (multidrop)**

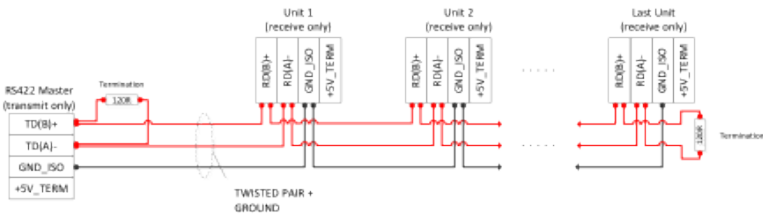

**5.1.6.4 RS-422: 4-wire connection (2 units only)**

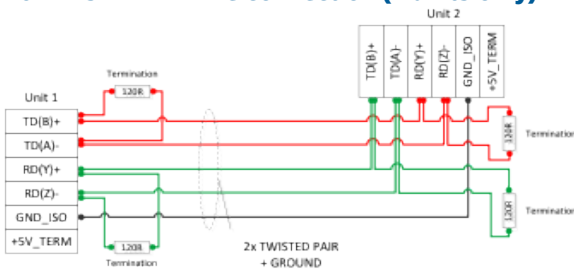

## 5.1.7 Failsafe RS-485/422 termination

When there is no data on the bus (no node is transmitting), the RS-4xx signal pair floats free. In principle both signals ('a' and 'b') should be floating at the same potential. However, due to possible outside disturbances, this is not always the case.

According to the RS-4xx standard, the receiver interprets signals as either logic high or low depending on the difference in potential between a and b. A potential difference of greater than 0.4 V is required for the receiver to decide whether the signal is low or high. In practice most receivers make the decision at greater than 0.2 V level.

The RS-485 receiver output is typically logical '1' when the inputs are floating. When a disturbance causes, the potential difference to increase logic '0' is easily detected. This is then interpreted as a start bit by the receiver on the RS-4xx bus, resulting in bit errors or garbled extra characters.

Another method of error due to lack of failsafe termination is that once a node starts transmitting on the line, the receiver which already senses a '0', misses the transition from stop bit to start bit, needed to synchronize a UART transmission. Thus the receiver in error will receive the first data byte wrong, and depending on the number of stop bits and a pause between bytes on the line, might miss also the following bytes or even an entire packet.

This is a potential error mechanism, which can be easily overcome by pulling the 'a' line high and the 'b' line low by connecting the wires thru a series resistor to the desired potential.

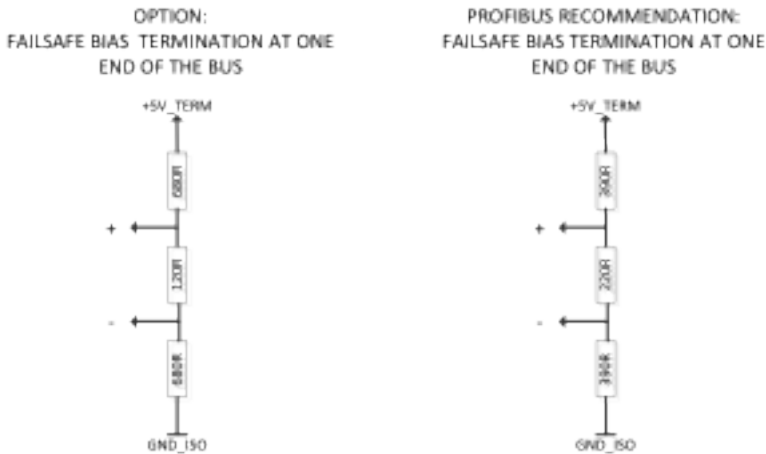

Figure 5.3 Failsafe termination examples

## 5.2 Radio

The RU has a TNC female RF connector with impedance of 50 ohms. The frequency range of the RU is coded in the type designation, which can be seen on the label back of the RU. The details of this are explained in chapter 8.

The RF frequency can be set in 6.25 kHz steps. The RU supports three different channel spacing settings that can be selected by software. For FSK-radio these are 12.5, 25 and 150 kHz, and for QAM-radio 6.25, 12.5 and 25 kHz. Also three different modulation methods are supported. For FSK-radio these are 4-, 8- and 16-FSK and for QAM-radio these are 2-, 4-, 8-, 16-, 32- and 64-QAM.

The output power can be adjusted with steps 0.1, 0.2, 0.5, 1, 2 and 5 W. With for FSK radio these are constant envelope values but with QAM-radio these power levels are peak values due to crest factor (the ratio of peak values to the effective value) in QAM modulation. Crest factor varies between QAM modulation levels and the difference between peak power value and average power value can be in range of 6-9 dBm. E.g. for 5 W (37dBm) peak power value, the average power level is ~1W (30dBm). It should be noted that average values should be used when defining radio link budgets of a network.

Channel spacing together with the modulation method determines the air speed as clarified in the technical specification in chapter 2. Air speed can be set independently of the data rate of the serial port.

The modulation method also affects the receiver sensitivity. The best sensitivity can be obtained by the lowest level modulation, i.e. 4-FSK/2-QAM in SATELLAR XT 5R case. For typical sensitivities in different conditions see the technical specification in chapter 2.

Another method to improve the sensitivity of the receiver is to use Forward Error Correction (FEC), this can be used for SATELLAR XT 5R with 4- and 8-FSK modulations. This improvement effects the user data rate: the air speed remains the same but the fraction of bits available for the user is as indicated by the code rate of the FEC. The RU offers two different code rates, 0.67 and 0.5. For example, if 4-FSK is used with 25 kHz and the FEC is switched on with the code rate of 0.5 the user bit rate goes down to 9600 bits/s. The effect of the FEC on the sensitivity depends on the code rate and the level of BER (Bit Error Rate) at which the radio link is operating.

Changing of the modulation method or using FEC helps to improve the receiver sensitivity in noisy connections, i.e. the bit errors are mostly evenly distributed over the entire transmission period. If the errors happen in bursts these methods are not very efficient. For this reason the FEC is used together with the interleaving method. This means that before transmitting the data from the DTE, the RU collects a certain amount of data to the buffer and rearranges it according to a certain rule. The receiver knows the rule and recovers the original order of data bits. The receiver then sees the errors scattered and the FEC can correct the errors. It should, however, be noted that FEC and interleaving increase the latency and should be avoided in transparent mode in cases where a low latency is a primary requirement.

QAM-radio supports trellis coding with 8-, 16-, 32- and 64-QAM modulations which does not increase symbol rate nor expand the bandwidth. However it can introduce coding gain and thus improve the S/N ratio compared to uncoded system. Trellis coding has effect on latency and it can be disabled if the low latency is the primary concern. Trellis coding is enable by default.

## 3

### 5.3 DC supply

The DC connector of the RU is a detachable / lockable screw terminal. The DC voltage range is 10.6-30 V. The power supply used should be able to deliver at least 17.9 W of DC power. Please note that the RU delivers DC power to the entire stack of SATELLAR units. So when using the RU together with CU the power consumption of the entire stack must be taken into account when selecting the DC power supply.

### 5.4 Diagnostics, monitoring, changing settings

The settings of the RU can be viewed and changed by SATELLAR NMS PC SW. The computer is then connected to the serial connector of the RU and the connector must be configured to accept NMS messages. If the basic radio settings have previously been set locally it is also possible to establish a remote connection to another RU and change and view the settings of that modem over-the-air.

When the RU operates together with the CU with a display and a keypad, the device settings can be viewed and changed via the graphical user interface of the CU. Alternatively; the Web interface can be used.

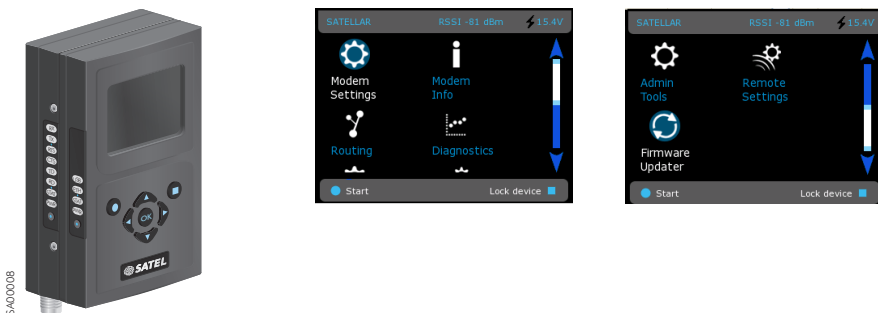

Figure 5.4 RU together with Central Unit (CU) equipped with LCD display and keypad, the main views

## 5. Interfaces

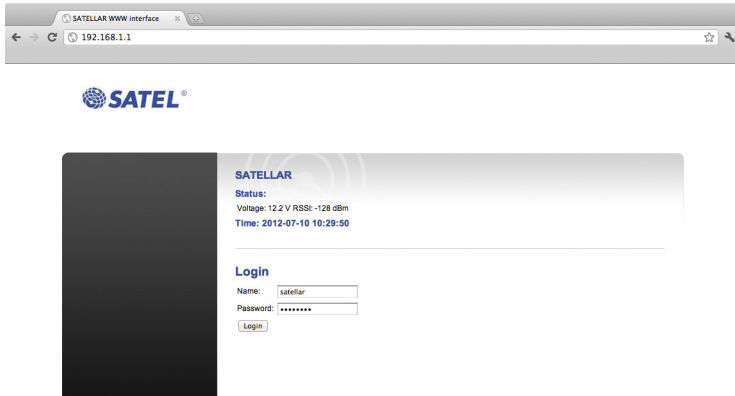
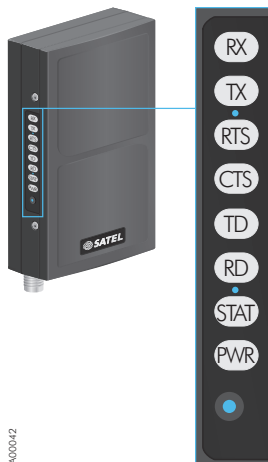

Figure 5.5 SATELLAR WWW interface Login view

Settings are described in chapter 7, serial data connector configuration especially in chapter 7.3, and the use of the PC software is described in its own documentation.

## 5.5 LED indicators

The RU provides eight LED indicators that are located on the other narrow side of the unit. They are listed and described in the table below.



3400042

Figure 5.6 LED indicators

Name	Description
RX	Receive data over radio
TX	Transmit data over radio
RTS	Request To Send; more details in chapter 6.6.2
CTS	Clear To Send; more details in chapter 6.6.2
TD	Transmit Data over the serial interface
RD	Receive Data over the serial interface
STAT	ON: power is on, the RU has been initialized and ready to operate OFF: the RU is not ready to operate
PWR	ON: power connected OFF: power not connected

## 5.6 Function button

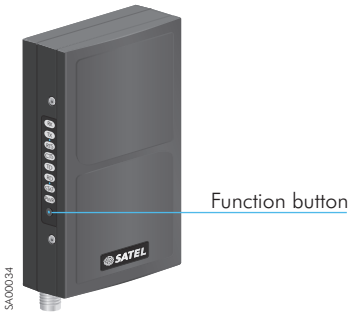

Figure 5.7 Location of the function button

The function button is located below the LED indicators. By pressing the button you can restart or temporarily configure the serial data connector to accept NMS messages and thereby getting the RU accessible by NMS PC SW for viewing and changing the settings irrespective of the user settings.

### Example 1:

The RU is connected with the CU and the user has selected the setting 'MCU UARTs to SATBUS' (see chapter 7.3). Now both the data and NMS messages are assumed to flow between the RU and the CU, so there is no connection at the serial data connector. Then the CU gets broken or is removed before changing this setting. By pressing the function button it is possible to temporarily configure the serial data connector to accept NMS messages, which means that the RU is accessible by NMS PC SW. Thereafter the settings can be viewed and changed irrespective of the serial connector configuration.

### Example 2:

The RU is used in the transparent mode of data transmission (serial data connector configuration 'Data UART to radio D9 RD/TD') and there is a temporary need to change or view settings using the CU. By pressing the function button it is possible to temporarily configure the NMS messages to flow between the RU and CU.

The duration of the button pressing determines to which state the serial data connector is configured as described in the table below. For the names of the LED indicators, see chapter 5.5. When the button is released the LED indicators return to the normal state.

## 5. Interfaces

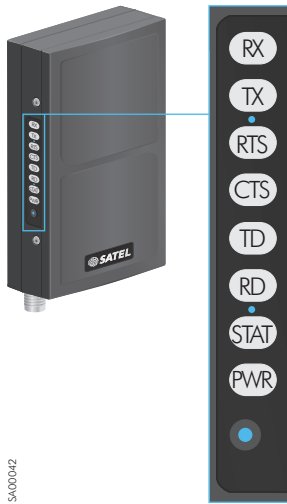
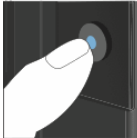





Figure 5.8 Function button operation by LED indication

Duration of the press	Indication	LED	Specific to HW variant	Effect	Typical use case
Less than 1s 	All the LEDs are switched on (1111 1111)			The serial data connector is reset to the state defined by the user (see chapter 7.3)	
More than 1s	The uppermost LED (RX) is switched off (0111 1111)			The serial data connector is deactivated, i.e. the user data traffic and NMS messages flow internally between the Radio and Central units	Serial port configuration other than MCU UARTs to SATBUS WITH CAN (see chapter 7.3). Need to temporarily connect the RU to the Central unit.
More than 2s	The two uppermost LEDs are switched off (0011 1111)			NMS messages in RD and TD lines (protocol RS-232), no user data transfer. NOTE! Does not take the effect if CU is connected.	Serial port configuration: Data UART to radio D9 RD/ TD (see chapter 7.3). Need to temporarily configure the RU using NMS from a PC.

Duration of the press	Indication	LED	Specific to HW variant	Effect	Typical use case
More than 3s	The three uppermost LEDs are switched off (0001 1111)		RU-xxxx00	NMS messages in RTS and CTS lines, no user data transfer	
More than 4s	The four uppermost LEDs are switched off (0000 1111)			User data transfer in RD and TD lines (protocol RS-232), NMS messages between the Radio and Central units	Serial port configuration: Data UART to radio D9 RD/ TD (see chapter 7.3). Need to temporarily configure the RU using NMS from the Central unit. Normally this mode is selected by configuring the serial port as described in section 7.3.
More than 5 s	The lowest three LEDs remain switched on (0000 0111)		RU-xxxx01	NMS messages in RD and TD lines (protocol RS-485), no user data transfer	Serial port configuration: RS-485 (see chapter 7.3). Need to temporarily configure the RU using NMS from a PC.
More than 6 s	The lowest two LEDs remain switched on (0000 0011)		RU-xxxx01	NMS messages in RD and TD lines (protocol RS-422), no user data transfer	Serial port configuration: RS-422 (see chapter 7.3). Need to temporarily configure the RU using NMS from a PC.
More than 7 s	The lowest LED remain switched on (0000 0001)			No effect	
More than 8 s	All the LEDs switched off (0000 0000)			The RU is restarted and the serial data connector is reset to the state defined by the user	

Table 5.3 Function button operation

## 6. Data transmission

In order to transfer data, the RU must be configured to operate in one of the following modes

- Basic, TX priority
- Basic, RX priority
- Basic, repeater
- Source routing, master (supported with FSK-radio)
- Source routing, slave (supported with FSK-radio)
- Packet routing

These are called network protocol modes. Basic mode with TX priority is the traditional transparent mode of data transmission, where the RU is effectively replacing a cable between two Data Terminal Equipments. In basic mode with RX priority the transmission is disabled as long as there is a reception ongoing. In repeater mode the data received from the radio path is buffered and then forwarded back to the radio path. Repeater mode is used to extend the radio coverage.

Source routing (supported only with FSK-radio) is needed when the network topology is more complicated than just a point-to-point connection between two stations (possibly added by a repeater station). This mode requires polling type protocols with fixed station address length and position in the message, based on RS-232, -422, and -485.

Packet routing is typically in use when the RU is working together with the CU. The CU interfaces with the DTE using the IP protocol stack and acts as an IP router. The RU is seen as a virtual network interface and does not need to be especially configured for the IP traffic. However, settings related to medium access control (see explanation later in this chapter) must be done and routing tables must be filled. As explained earlier, the RU can act as a radio router station without the CU also in cases where IP data is transferred. Only when a local Ethernet connection is needed the CU must be used.

### 6.1 Basic mode with TX priority

When the RU operates in basic mode with TX priority, the Data Terminal Equipment (DTE) is connected to the serial data connector (D9). Data transfer starts immediately when the first byte of data comes from the DTE and stops when the data ends. The RU does not store the data anywhere and does not rearrange it at all. It just sends the data that it gets as input. The radio link between the two DTE is done without routers or repeaters in between. This mode is a simple point-to-point connection where the connecting cable is replaced by a radio link. The DTE is fully responsible for the traffic control: it decides when to transmit, interprets the incoming data for correctness and decides further transmission is needed.

The basic mode with TX priority offers the shortest possible latency – the time needed for a receiving DTE to receive the first byte of data from the instant the sending DTE has initiated the transmission. The factors affecting the latency in the RU are:

- Receive-transmit turn-around time: The RU is normally in reception mode, i.e. listens to the radio channel. When it recognizes that the DTE wants to send data it switches to transmission mode, which requires a certain time to happen in the radio hardware.
- Delays in filters: Channel filtering both in the transmitter and the receiver required to meet the radio standards (like EN 300 113) generates a delay in the radio link.
- RF power ramp-up time: The RF power cannot be switched on extremely fast because of the transient spectrum requirements of the radio standards.
- Synchronization: After the RF power ramp-up there must be a certain synchronization sequence during which the receiver adjusts to the frequency and timing of the transmitting radio. It then decides whether the received signal is a valid transmission instead of an external interferer.
- In addition the factors affecting the latency are
- Forward error correction (only with FSK-radio): The principle of forward error correction is to read a few bits to a data register and generate a codeword based on a certain mathematical formula and the stored data bits. This at first generates some delay in the transmitter but especially in the receiver where a longer bit sequence must be stored before being able to decode the incoming codeword.
- Encryption in the radio path: The principle of encryption is to collect a certain amount of data to a shift register and manipulate it according to a certain rule. The process of encryption adds delay in the data flow and must be avoided in the cases where low latency is the most important requirement.
- Trellis Coding (only with QAM-radio): Trellis coding is used to introduce coding gain that brings benefit for receiver sensitivity especially in noisy environment. This is causing some decoding delay which can introduce additional latency. Trellis coding can be set to OFF when latency is the most important requirement.

Strictly speaking the last two factors violate the principle of transparent data transmission (no modifications to the content of the data). However, this is more or less a matter of definition. More important is to understand that switching these on affects the latency and must not be done in applications where low latency is a critical requirement.

To use the RU in basic mode with TX priority:

- Configure the data port settings as required by the used data transmission protocol (data rate, number of data bits, number of stop bits, parity).
- Set the network protocol mode to basic, TX priority
- If required modify the pause length parameter (see chapter 6.6.4. for explanation)
- Set the serial port configuration so that Data UART goes to Radio D9 RD/TD (see chapter 7.3 for explanation)
- Set all the radio parameters as required (unless already set in the factory): radio frequency, channel spacing, RF output power, modulation method, forward error correction (FSK)/trellis coding (QAM) and encryption.

## 6.2 Basic mode with RX priority

Basic mode with RX priority is similar to TX priority. The difference is in how the RU reacts to the incoming data from the DTE: when the priority is TX the transmission is started without delay even when there is a reception ongoing while in RX priority the transmission is started just after the reception has been completed.

An example of how to use priority settings in a simple network is shown in the figure below.

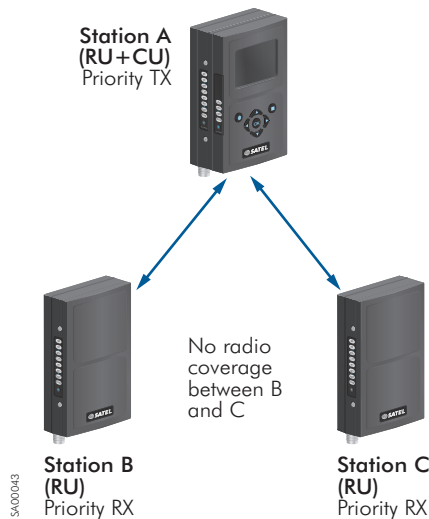

Figure 6.1 Priority settings in a simple network

Station 'A' has a radio link to stations 'B' and 'C'. It sends control commands to these. Stations 'B' and 'C' respond by sending either status information or acknowledgement messages. They cannot hear each other's radio transmissions. Control commands from station 'A' are of high priority, so station 'A' needs to start sending despite it has an incoming message. Therefore station 'A' is set to priority TX while the others are set to priority RX.

Priority settings help if the radio coverage is as described in the figure above, i.e. if station 'B' and 'C' cannot hear each others' transmissions. Consider a situation where station 'B' is sending to 'A' and 'A' then needs to send a high priority message to station 'C' while it still has reception ongoing from 'B'. Due to priority setting to TX it is possible but if stations 'B' and 'C' are within each others' radio coverage the two simultaneous messages from 'A' and 'B' collide at 'C' and therefore the message from 'A' is probably not received correctly. This kind of situation cannot be solved with priority settings but needs a more complicated handshaking procedure, which is explained in chapter 6.6.2. Priority settings help the important messages get through but must be used carefully keeping in mind that the stations set to priority RX may not be within each others' radio coverage.

### 6.3 Basic mode with repeater

Basic mode with repeater is used to extend the radio coverage by adding one RU operating in this mode between two basic mode RUs as described in the Figure 6.2.

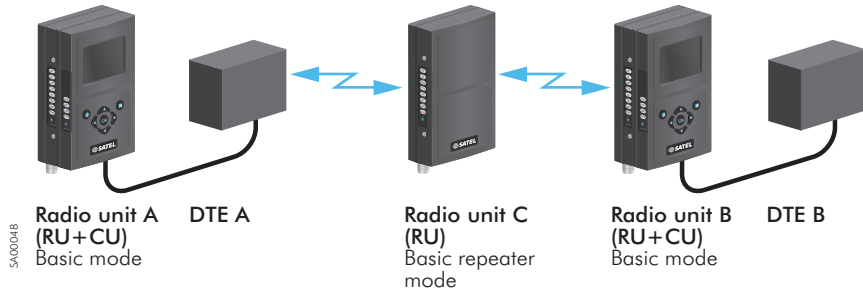

Figure 6.2 Basic repeater mode

RU 'C' stores all the data it receives and then forwards it to the radio path. There are no station addresses in the RU, i.e. the DTE, which just sent data gets it back after a while from the repeater station. Therefore the DTE must be able to disregard these messages.

### 6.4 Source routing

Source routing is supported with FSK-radio.

When two or more repeaters are used it is necessary to use addresses to route the data. This is because otherwise the repeaters would send the same messages to each other again and again in the network. When using source routing the radio stations are forwarding only the data that belongs to them, not all the data they hear in the network. The name source routing comes from the fact that only one station in the network can be used as an entry point, the source, for the routing data. This station is called a master and the other stations are slaves. Network topology is created with SATEL NMS PC software and sent to the master station, which then includes the routing data in the messages to the slave stations. The following picture clarifies the situation.

6. Data transmission

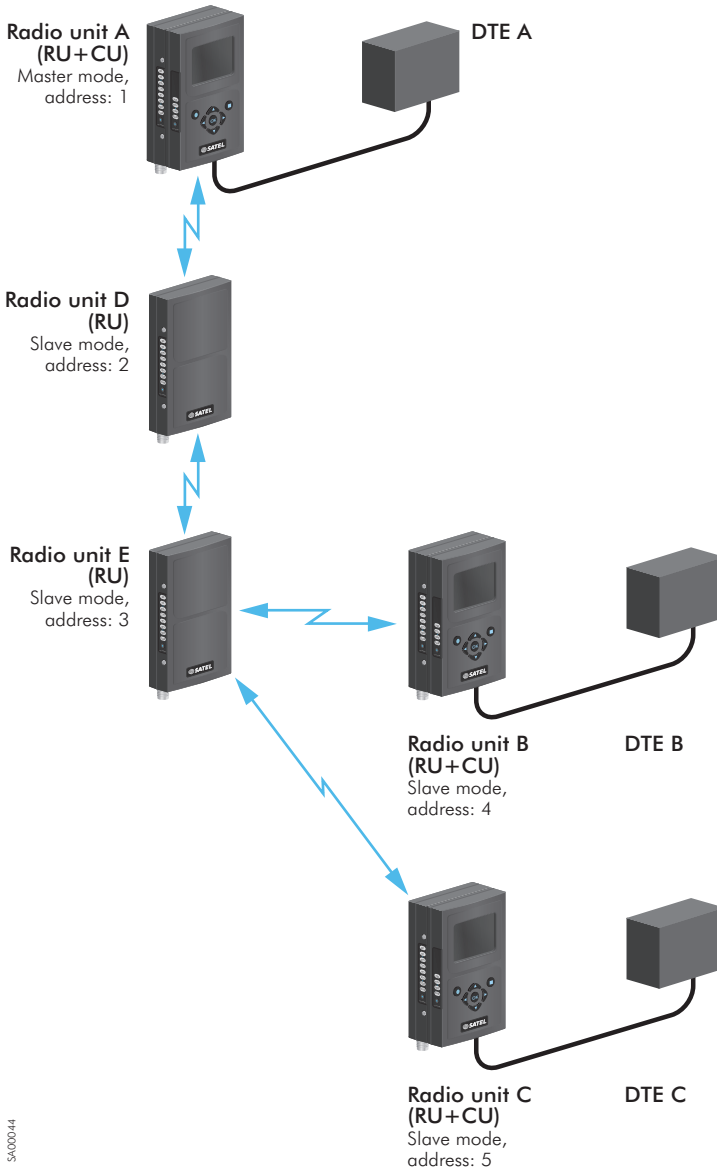

SX00044

Figure 6.3 Routing between master station and slave stations

RU 'A' acts as a master station in this network and has the following routing table in the memory:

<b>DTE</b>	<b>Route</b>
B	2, 3, 4
C	2, 3, 5

3

When DTE 'A' sends data e.g. to DTE 'B' the RU 'A' picks the address of the DTE 'B' from the message and then determines which route to use. In this example the route is the upper one, i.e. 2, 3, 4. Before sending the message the RU 'A' adds the route to the start of the message and in addition tells that the next receiver is station 'D' with address 2. All the other stations (not in the figure) except for 'D' that possibly hear the message ignore it. Station 'D' picks the message, copies the routing data, and modifies the next receiver indicator to point to station 'E' with address 3. The same procedure is repeated through the whole chain until the message reaches the destination DTE, 'B' in this example.

When DTE 'B' replies to 'A' the message goes through the router chain in an opposite direction. For example, when the reply message reaches station 'E', that remembers the route and forwards the message indicating that the next receiver is station 'D'. The route remains valid as long as the reply message has reached the original sender. For the next message the routing information must be sent again.

How the DTE includes the address data in the message depends on the used communication protocol. Adaptation to different protocols is done by the protocol filters that are available in SATEL NMS PC software. These filters tell to the RU how to interpret the incoming message. No special protocol support is needed in the RU firmware.

As explained earlier, source routing is used in polling type protocols with fixed station address length and position in the message, based on RS-232, -422, and -485.

## 6.5 Packet routing

An important limitation in the implementation of the source routing is that there is no radio access control behind, i.e. all the traffic must be originated by the master station: DTE 'A' sends a query message to DTE 'B' that then replies using the same radio route in the inverse order. Thereafter 'A' can send the same query to 'C' which also replies. In this way there occur no collisions on the radio channel. This amount of functionality is enough for the so-called polling protocols. A drawback, however, is that slave stations cannot generate any messages independently, e.g. automatic status reports from the slave stations are not possible. Another drawback is that the slave stations cannot communicate with each other.

The mentioned drawbacks can be overcome by using the RU in packet routing mode. This mode allows each station to be in connection with every other station and there is no master station, which initiates all the traffic in the network. Also, there is a radio access control to prevent data packet collisions in the radio path. The radio access control is briefly explained in chapter 6.5.1. The routing table is constructed so that each unit has one or more neighbor (next hop) addresses where to route the incoming data next. For every neighbor address are listed the addresses of the stations that are found behind it. Each station selects the correct neighbor station according to the final destination address and thereafter the data proceeds hop by hop towards the destination. As an example is presented how the routing table looks like for the network topology seen in the figure on page 42.

The routing table is the following:

Radio Unit	Next hop	Addresses behind
A	2	3, 4, 5
B	3	1, 2, 5
C	3	1, 2, 4
D	1	-
	3	4, 5
E	2	1
	4	-
	5	-

In this example the routing is very simple for RU 'A', 'B', and 'C' because they have only one possible next hop regardless of the final destination. Units 'D' and 'E', on the contrary, must select between multiple alternatives.

Primarily, packet mode routing is used when transferring data over IP. This requires a CU to be connected together with the RU, except for the radio router stations where the RU can operate alone. How the IP addresses are configured for IP transmission is explained in the CU user manual.

3

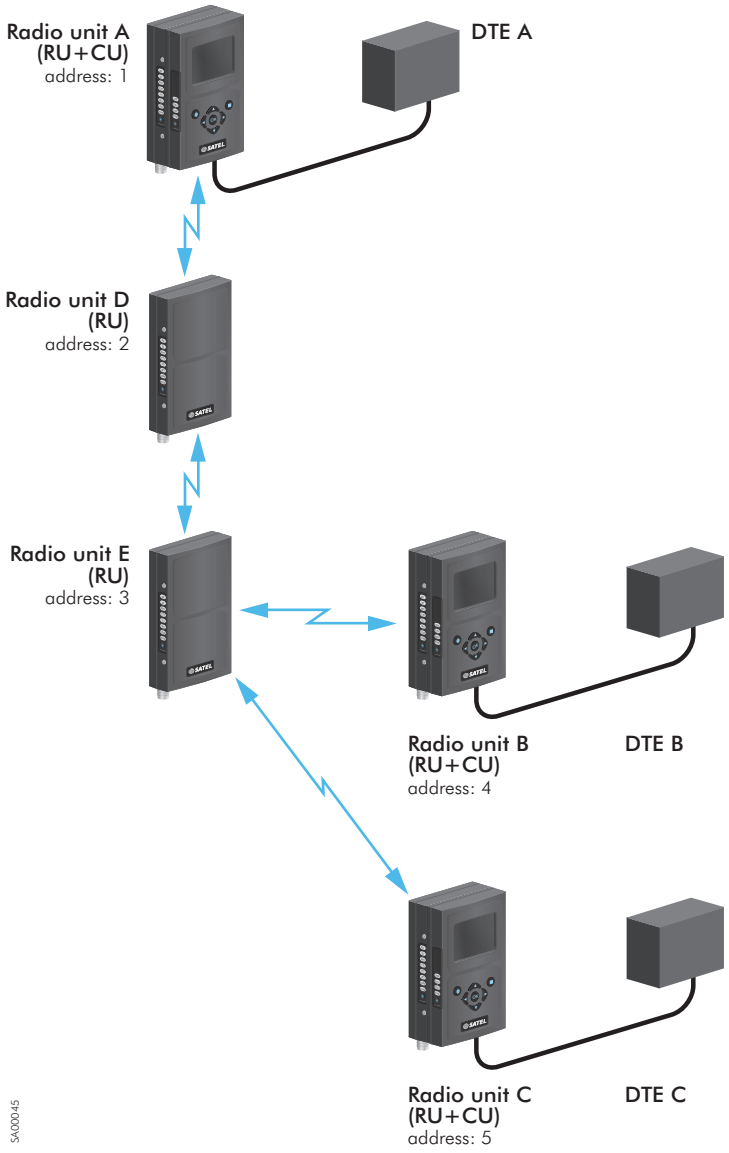

54/00045

Figure 6.4 Routing example

## 6.5.1 Radio access control

The purpose of radio access control is to prevent the data packets to collide with each other on the radio channel. This is particularly important in IP data transmission where the data packets are sent forward whenever there are any to be sent. In Ethernet there is a collision avoidance algorithm in use. However, it is strongly related to the fact that the network is built by using cables, i.e. all the stations can detect whether there is traffic on the line or not. Particular to the radio transmission is the presence of the so-called hidden terminals: the terminals, which are transmitting without every other terminal in the network to be able to detect that. The main purpose of the algorithm implemented in the RU is to provide a collision free operation also in the presence of hidden terminals. The algorithm is called CSMA/CA (Carrier Sense Multiple Access/Collision Avoidance) and is based on transmitting handshaking signals (RTS, CTS, ACK) between the stations. A pre-requisite for the algorithm to work is that each station in the network has an address and that there is a kind of routing table in use. The routing table tells each individual station which neighboring station to listen to and to which station to send data.

There are a few settings in the RU that controls the operation of the collision avoidance algorithm. Those are set in the factory so that the algorithm should perform well at the field as such. However, to reach the optimum performance for a particular use case the following properties of the network should be considered.

- Network topology: Are there only point-to-point connections in the network or are there one or more radio routers in use? If there are routers in the network, all the stations must remain silent for a while after each transmission, in order to give a possible radio router station a privilege to forward the message. By telling each of the RU that there are only point-to-point connections in the network, helps in saving this additional waiting time and thus increasing the data throughput. If the user application handles the data retransmission there is a fast mode setup which does not have the handshaking feature. It has the fastest data throughput but the tradeoff is that the data packets collide more often and the hidden terminal rejection feature is switched off. See chapter 7.6 for more information.
- Retransmissions at the radio protocol level: There might be retransmissions at the higher protocol layers (e.g. TCP) irrespective of this setting. Normally, retransmissions at the radio protocol level should be on if the data goes through one or more radio routers or if the higher protocol layers do not include retransmissions.
- Back-off counter: This defines the time how long a station must wait before starting a transmission in the case the radio channel is reserved. If the network is small, the back-off counter can be low because the probability of collisions is low. As the size of the network increases the back-off counter should be higher. The correct value should be found experimentally based on the number of stations and the amount of traffic.
- Signal threshold: QAM: Adjustable in the range of -80 ... -110 dBm. In Packet Routing mode, radio delays the TX for radio interface for 10ms if radio signal higher than the set Signal threshold trigger value is recognized. FSK: Adjustable in the range of -80 ... -127 dBm. Effects only to the CD line output in the serial communication mode.

- Data reception can not be blocked with Signal Threshold setting.
- NOTE! The Fast Mode selection is not available with 150 kHz channel.

## 6.6 Data flow control in basic and source routing mode

In this chapter is described what ways there are available to add control to the data flow in basic mode.

### 6.6.1 TX delay

TX delay can be used in a situation where a certain master station sends queries as broadcast messages to many sub-stations. To prevent the replies from the sub-stations to collide at the master station, you can set different TX delay values to each of the sub-stations. This means that a sub-station does not reply to the query until the TX delay period has been expired. TX delay is fixed, i.e. the maximum length of the reply message must be approximately known at the network configuration phase in order to really avoid collisions at the master station. TX delay can be considered as a primitive time-slot mechanism.

### 6.6.2 Handshaking

The handshaking lines of the serial data interface can be used to control the data flow from/to the RU. There are three different control lines for this purpose, namely CTS, RTS, and CD lines.

#### 6.6.2.1 CTS (Clear To Send)

The CTS line is normally in the active state, which means that the RU is ready to accept data from the DTE. When the RU sets the line to the inactive state the data transfer from the DTE to the RU is not possible.

There are four alternative criteria for the user to select when the CTS line goes to the inactive state. These are explained in the table below:

Selection	Description
Clear to send	Goes to the inactive state in the following cases: <ol style="list-style-type: none"> <li>1) Data reception is ongoing.</li> <li>2) A pause (packet end) has been detected in the transmitted data and there is still data in the transmission buffer. The line shifts back to the active state when the RU has finished the transmission.</li> <li>3) Transmission buffer is in danger of overflowing.</li> </ol>
TX buffer state	Goes to the inactive state only when the transmission buffer is in danger of overflowing. This happens typically in cases where the data rate of the serial interface is higher than the air speed.

## 6. Data transmission

RSSI threshold	Goes to the inactive state only when the received signal is stronger than the pre-defined threshold value.
Always on	The line is always in the active state.

Table 6.1 CTS line in inactive state

### 6.6.2.2 RTS (Request To Send)

The RTS line is normally in the active state, which means that the DTE is ready to accept data from the RU. When the DTE sets the line to the inactive state the data transfer from the RU to the DTE is not possible.

There are three alternatives for the user to select how the RU reacts when the RTS line goes to the inactive state. These are explained in the table below:

Selection	Description
Flow control	The RU continues the reception but buffers the received data until the RTS line goes back to the active state. This is typically used in situations where the DTE is too slow to receive all the data. The size of the receiver buffer is about 1.6 kBytes but must be checked for each particular HW and SW version if seen critical in the application.
Reception control	The RU stops the whole reception.
Ignore	The status of the RTS line is not followed at all.

Table 6.2 RTS line in inactive state

### 6.6.2.3 CD (Carrier Detect)

The CD line is an indicator from the RU to the DTE that a signal has been detected on the radio channel. There are three alternative criteria for the user to select when the line goes to the active state. These are explained in the table below:

Selection	Description
RSSI Threshold	Active when the received signal is stronger than the pre-defined threshold value.
Data on channel	Active when there is a data reception ongoing.
Always on	The line is always in the active state.

Table 6.3 CD line in inactive state

It depends on the application how the DTE reacts to the information provided by the CD line.

### 6.6.3 Error control

For error checking purposes there is a mechanisms in the RU: cyclic redundancy check (CRC).

*Cyclic redundancy check* is possible for the user to switch ON and OFF. The transmitter calculates the checksum based on the whole data stream, which has been sent and adds the checksum to the end of the data. If the CRC is on the receiver buffers the data and sends it forward after it has been able to verify that the checksum corresponds to the received data. A drawback in this is that the latency increases by the transfer time of the whole packet.

The basic guidelines how to use the error control features are the following:

- When it is important to be sure that the data is correct but the latency is not critical: switch the CRC ON. The number of allowed illegal characters is not relevant.
- When it is important to be sure that the data is correct and the latency is critical: switch the CRC OFF and set the number of allowed illegal characters to zero.
- When every received character being correct it is not critical: switch the CRC OFF and set the number of allowed illegal characters to a certain reasonable value, e.g. to 10.

### 6.6.4 Pause length

Pauses are used to separate two messages from each other at the serial interface. A typical pause length, which is interpreted, as the end of the message is three characters. However, non-real time operating systems used in many DTE easily add random pauses in the data stream. Those pauses are then seen as message breaking points in the RU. To overcome this situation pause length parameter has been introduced and must be set higher than the worst-case pause in the data stream. The data stream from the DTE must then take this setting into account: the RU does not recognize the pauses that are shorter than the value of the pause length parameter.

# 7. Settings

As mentioned in chapter 5.4 settings can be viewed and changed by SATEL NMS PC software or by the user interfaces of the CU. Settings have been described in earlier chapters in conjunction with the overall descriptions of the different functionalities. Here below is presented a summary of all the user related parameters and how they are organized in groups.

## 7.1 Network protocol modes

As explained in the beginning of chapter 6 the RU can be configured to operate in the following network protocol modes:

- Basic, TX priority
- Basic, RX priority
- Basic, Repeater
- Source Routing-Master (supported with FSK-radio)
- Source Routing-Slave (supported with FSK-radio)
- Packet Routing

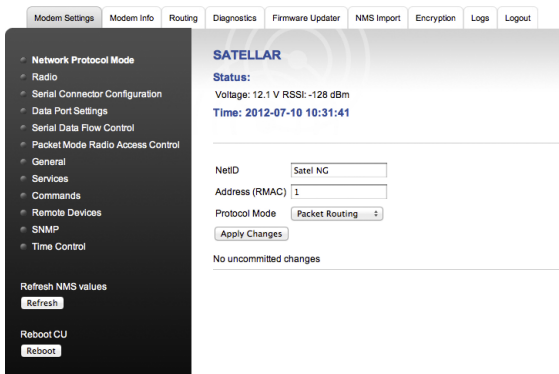

Figure 7.1 Network Protocol Mode settings view; WWW interface



Figure 7.2 Modem Settings, Network Protocol Mode; by CU interface

## 7.1.1 Station addresses and network ID

If the RU is configured to operate either in source or packet route mode, it must be given an address. The address is freely selectable between 1 and 4093, see Figures 7.1 and 7.2.

The network ID is used to distinguish the different closely located networks from each other. The network ID is a string with maximum length of eight characters.

## 7.2 Radio settings

RX Frequency	RF frequency of the receiver in MHz, e.g. 451.106250 MHz: can be adjusted by a numeric editor.
TX Frequency	RF frequency of the transmitter in MHz, e.g. 451.106250 MHz: can be adjusted by a numeric editor.
RF Output Power	RF output power in mW. Adjustable between 0.1 – 5W. (With QAM-radio these are peak values)
Signal Threshold	Received signal threshold level used in handshaking and in packet mode medium access control (chapters 6.6.2 and 6.5.1).
Over-the-Air Encryption	Can be either OFF or ON. In addition AES128/AES256 can be selected.
Forward Error Correction	Can be selected from a predefined list of OFF, rate 67 %, and rate 50 %. Forward error correction is used together with interleaving. See chapter 5.2 for more information.
Trellis Coding	Can be set ON or OFF. See chapter 5.2 for more information
Channel Spacing	FSK-radio: 12.5, 25, 150 kHz. QAM-radio: 6.25, 12.5, 25 kHz
Air Speed	Can be selected from a predefined list that depends on the selected channel spacing and available modulation methods as explained in chapter 5.2. If the channel spacing is changed the air speed needs to be changed as well.

Table 7.1 Modem Settings, Radio

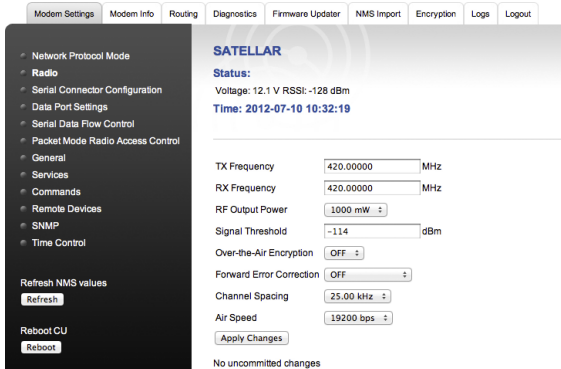

Figure 7.3 Radio settings view; WWW interface



Figure 7.4 Modem Settings, Radio; by CU interface

## 7.3 Serial connector configuration

The setting selected here becomes active whenever the RU is switched on. If the setting has been changed by pressing the function button as described in chapter 5.6, this setting becomes active again when the function button is pressed for less than a second. The configuration options are the following:

3

### Radio unit with RS-232 interface with handshaking

Can be selected from a predefined list of:

- MCU UARTs (Data and NMS) to SATBUS (normal setting when RU is permanently operating with the CU).
- Data UART to Radio D9 RD/TD (standard RS-232 interface, normal setting when the RU is operating in transparent mode of data transfer).
- Data UART to Radio D9 RD/TD – NMS to DTR/DSR (RS-232 data transfer using handshaking, need to simultaneous monitoring using NMS).
- Data UART to Radio D9 RD/TD – NMS to RTS/CTS (RS-232 data transfer without handshaking, an alternative to the previous setting).
- Data UART to Radio D9 RD/TD – NMS to SATBUS (standard RS-232 interface, need to use the CU as a configuration tool).
- MCU UARTs (Data and NMS) to SATBUS with CAN.

### Radio unit with RS-422/-485/-232 interface without handshaking

Can be selected from a predefined list of:

- RS-422
- RS-485
- RS-232 (RD, TD & SGND only)

In the latter model it is not possible to have simultaneous data and NMS. However, the serial connector can be configured to accept offline NMS messages as explained in chapter 5.6.

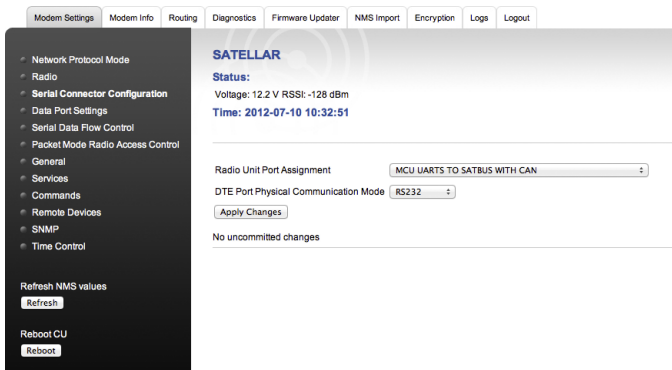

Figure 7.5 Serial Connector Configurator view; WWW interface

## 7. Settings

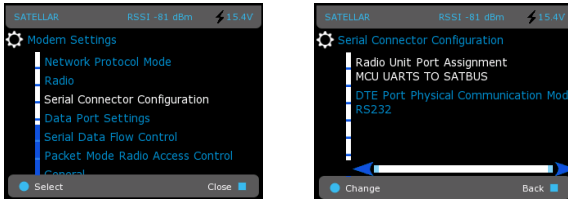

Figure 7.6 Modem Settings, Serial Connector Configuration; by CU interface

## 7.4 Data port settings

Limitations applies only to Transparent-, and Source Routing –modes. See further details from section 5.1 Serial data, page 24.

Data rate	1200*, 2400*, 4800*, 9600, 19200, 38400, 57600 and 115200 bits/s *) Supported only in FSK models
-----------	---

Number of data bits	8 bits
---------------------	--------

Parity	No Parity Check, Even, and Odd
--------	--------------------------------

Number of stop bits	1 bit
---------------------	-------

Table 7.2 Modem Settings, Data Port Settings

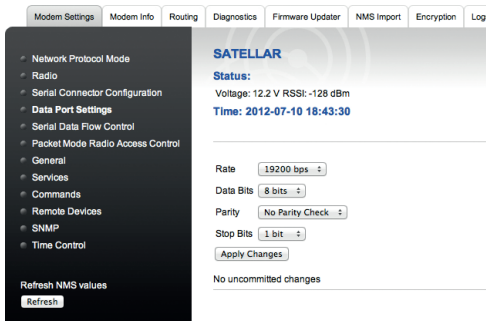

Figure 7.7 Data Port Settings view; WWW interface

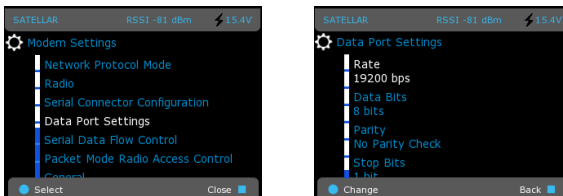

Figure 7.8 Modem Settings, Data Port Settings; by CU interface

## 7.5 Serial data flow control

TX delay	0 – 65535 ms. See chapter 6.6.1 for more details.
Error control	<b>CRC:</b> ON or OFF. See chapter 6.6.3 for more details. Maximum number of accepted errors: See chapter 6.6.3 for more details.
Handshaking lines	<b>CTS:</b> Can be selected from a predefined list of Clear to send, TX buffer state, RSSI threshold, and Always on. See chapter 6.6.2 for more details. <b>RTS:</b> Can be selected from a predefined list of Flow control, Reception control, and Ignore. See chapter 6.6.2 for more details. <b>CD:</b> Can be selected from a predefined list of RSSI threshold, Data on channel, and Always on. See chapter 6.6.2 for more details.
Pause length	3 – 255 bytes. See chapter 6.6.4 for more details.

Table 7.3 Modem Settings, Serial Data Flow Control

The screenshot shows the SATELLAR web interface. The top navigation bar includes: Modem Settings, Modem Info, Routing, Diagnostics, Firmware Updater, NMS Import, Encryption, Logs, and Logout. The left sidebar menu lists: Network Protocol Mode, Radio, Serial Connector Configuration, Data Port Settings, Serial Data Flow Control (highlighted), Packet Mode Radio Access Control, General, Services, Commands, Remote Devices, SNMP, and Time Control. Below the menu are buttons for 'Refresh NMS values' and 'Reboot CU'. The main content area displays the 'Serial Data Flow Control' settings:

- Status: Voltage: 12.2 V RSSI: -128 dBm, Time: 2012-07-10 18:44:14
- TX Delay: 0 ms
- CRC: ON
- Handshaking CTS Line: TX buffer state
- Handshaking RTS Line: Ignored
- Handshaking CD Line: RSSI threshold
- Pause Length: 3 bytes
- Maximum Number of Accepted Errors: 0
- Buttons: Apply Changes, No uncommitted changes

Figure 7.9 Serial Data Flow Control view; WWW interface

The three screenshots show the mobile interface for SATELLAR. The first screenshot shows the 'Modem Settings' menu with 'Serial Data Flow Control' selected. The second screenshot shows the 'Serial Data Flow Control' settings screen with the following values:

- TX Delay: 3 ms
- CRC: ON
- Handshaking CTS Line: TX buffer state
- Handshaking RTS Line: Ignored
- Pause Length: 3 bytes
- Maximum Number of Accepted Errors: 0

The third screenshot shows the same settings screen with a 'Change' button highlighted at the bottom.

Figure 7.10 Modem Settings, Serial Data Flow Control; by CU interface

## 7.6 Packet mode radio access control

Packet mode radio access control is briefly explained in chapter 6.5.1.

Feature	Explanation	Sub unit	NMSID
Network topology *) / Handshake *)	<p><b>FSK models (Network Topology)</b></p> <p><b>Point to point **)</b> -mode: Recommended for the radio networks where all the radio modems can reach each other and the data collision avoidance is required to the radio interface. Data retransmissions can be set ON/OFF at radio layer. With RTS+CTS radio layer handshaking function.</p> <p><b>Repeater</b> -mode: Recommended for the radio networks where all the radio modems can't reach each other directly. Data retransmissions can be set ON/OFF at radio layer. With RTS+CTS handshaking function. Longer CTS reply at the receiving radio, which is received in hidden terminal cases where part of the radio network can't receive the original RTS message.</p> <p><b>Fast mode</b> -mode: only for radio networks with limited amount of devices, where anti collision in the air interface is taken into account in other part of the system. No data retransmissions in the radio layer, no handshaking for the radio layer.</p> <p>Radio layer handshaking done always with 2FSK radio modulation regardless of the user selected air rate. Radio layer handshaking not displayed with TX/RX led indicators.</p> <p><b>QAM models (Handshake)</b></p> <p><b>HS OFF</b> -mode: Notification of transmission to begin. Radio layer handshaking: CTSS &gt; DATA &gt; ACK (if Retransmissions enabled in transmitting radio).</p> <p><b>HS ON</b> -mode: Notification of the transmission to begin is approved by the receiving radio layer handshaking: RTS -&gt; CTS -&gt; DATA -&gt; ACK (if Retransmissions enabled in transmitting radio). RTS retransmissions always enabled. CTS message is received also in other radio routers in the radio network for "hidden terminal" cases, where part of the radio network can't receive the original RTS message.</p> <p>Handshaking in the radio layer done always with selected QAM modulation. Data retransmission in the radio layer possible in both cases. Handshaking messages include the "channel reserved" information. Radio layer handshaking displayed with TX/RX led indicators.</p>	0	1.430

Retransmissions (Packet Mode Radio)	<p><b>FSK models</b></p> <ul style="list-style-type: none"> <li>- Retransmissions for data and RTS in Point-to-point and Repeater network topology modes.</li> <li>- When enabled, RTS message is retransmitted max. 4 times, data max. 2 times.</li> <li>- Retransmission process executed after the set max. Back Off Counter Value.</li> </ul> <p><b>QAM models</b></p> <ul style="list-style-type: none"> <li>- Retransmissions for data in the radio layer.</li> <li>- When enabled, radio router executes the retransmissions according to the adjusted time limit (see Packet expiration time).</li> <li>- Retransmissions done after max. packet length if RTS/CTS/ACK messages are not recognized from the radio network.</li> <li>- Can be set differently to radio routers in the radio network.</li> </ul>	0	1.2003
Back off counter (Packet Mode Radio)	<p>Defines the retransmission time for radio layer handshaking messages in case the radio channel is occupied.</p> <p><b>FSK models**):</b> Shall be set equally to the radio network devices.</p> <ul style="list-style-type: none"> <li>- With Fast Mode –mode selection, raffling done always if back-off counter greater than 0</li> </ul> <p><b>QAM models</b></p> <ul style="list-style-type: none"> <li>- Can be set differently to radio routers in the radio network</li> <li>- Modem decides when to freeze the BOC value. Priority (transmission turn) raises higher in every lost transmission turn (only remaining BOCV are taken into account in the next raffle time for the same data paket).</li> </ul>	0	1.2040
Packet expiration time (Packet Mode Radio)  NOTE! Only in QAM modulation models!	<p>0 (ms)*. Recommended to be set to differ from the factory value, e.g. 1000 (ms)</p> <ul style="list-style-type: none"> <li>- Data retransmissions in the radio layer (if enabled) and transmission request (RTS) max. sending period, if the radio network is occupied.</li> <li>- NOTE! The set time value is extended if the retransmitting radio notices other transmissions in the radio network and is forced to wait.</li> </ul>	0	1.365

\*) Default setting

\*\*) NOTE! The settings must be set equally to all radio modems in the same radio network.

RTS = request to send

CTS = clear to send

ACK = acknowledgement for the data packet

## 7. Settings

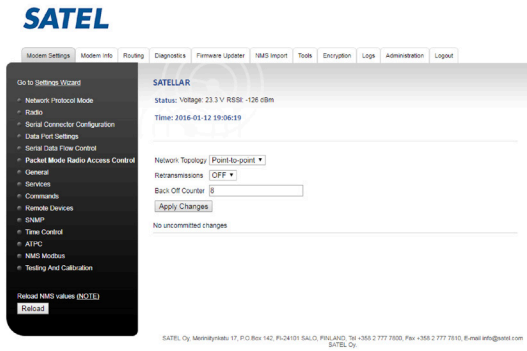

3

Figure 7.11 Packet Mode Radio Access Control; FSK model by WEB user interface

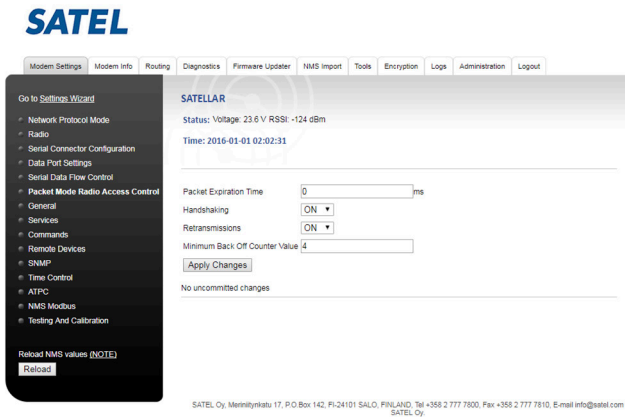
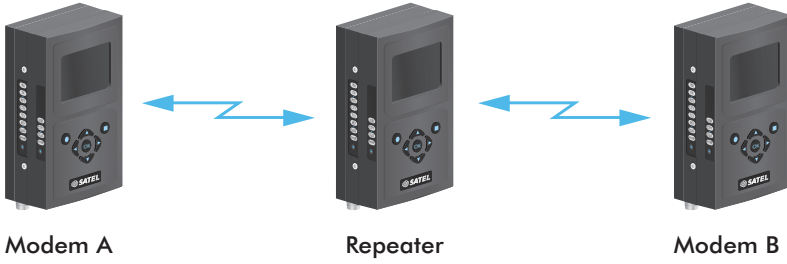
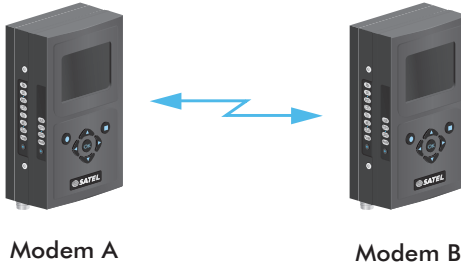

Figure 7.12 Packet Mode Radio Access Control; QAM model by WEB user interface



Network topology: Repeater  
Setting: Repeater



Network topology: Point-to-Point  
Setting: Point-to-Point or Fast mode

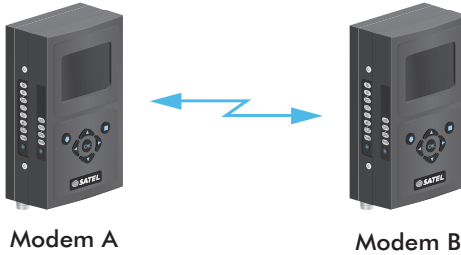

Network topology: Master-Slave  
Setting: Point-to-Point or Fast mode

3

Figure 7.13 Examples of the network topologies and corresponding settings with FSK model. Please contact SATEL for further information regarding the recommended setting for the operational mode.

## 8. Accessories

The RU is delivered with the following accessories:

- A DC connector
- Cable shield for the DC connector
- A user guide

The SATELLAR specific DIN rail adapter and wal mount parts can be ordered separately. If the RU is used as a standalone device, it can be delivered with a plastic front cover.

## 9. SATEL open source statements

ALL OPEN SOURCE SOFTWARE used in this product is distributed WITHOUT ANY WARRANTY and is subject to copyrights of one or more respective authors.

### 3

### 9.1 AES Encryption

This product includes cryptographic “**Advanced Encryption Standard**” software. AES implementation copyright (c) 1998-2008, Brian Gladman, Worcester, UK. All rights reserved.

#### License terms

The redistribution and use of this software (with or without changes) is allowed without the payment of fees or royalties provided that:

1. Source code distributions include the above copyright notice, this list of conditions and the following disclaimer;
2. Binary distributions include the above copyright notice, this list of conditions and the following disclaimer in their documentation;
3. The name of the copyright holder is not used to endorse products built using this software without specific written permission.

#### Disclaimer

This software is provided ‘as is’ with no explicit or implied warranties in respect of its properties, including, but not limited to, correctness and/or fitness for purpose.

# 10. Troubleshooting

## 10.1 Error codes



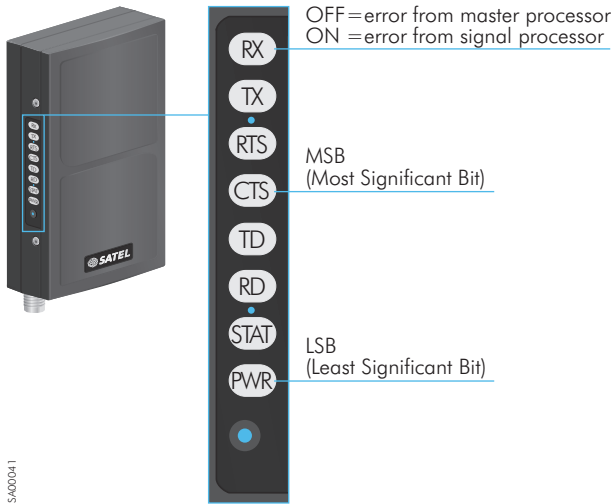

If the RU displays an error state, an error message is displayed for the user as a five digit binary number. The LED indicators will blink slowly, about once in a second, alternating between all indicators on and the error code on condition. LSB (least significant bit) is in PWR and MSB (most significant bit) in CTS. In addition by the uppermost LED (RX) there is indicator which a processor will report the error. If the RX LED is off the error originates from the master processor and if it is on the error report is from the signal processor. The error codes are presented in the table below.



Name	Description	Code	LED	Required action
ERROR_CAT_FPGA_VERSION	FPGA is not compatible with the firmware version	0 0001 (1)		Switch to the previous firmware version. If not possible the unit should be sent to service.

Name	Description	Code	LED	Required action
ERROR_CAT_FPGA_COMM	Error in FPGA MCU communication	0 0010 (2)	• • • • • • • • • •	Switch to the previous firmware version. If not possible the unit should be sent to service.
ERROR_CAT_BOARD_VERSION	PWB version not compatible with the firmware version	0 0011 (3)	• • • • • • • • • •	Switch to the previous firmware version. If not possible the unit should be sent to service.
ERROR_CAT_HW_INIT_GENERAL	Problem in HW initialization (other than memory related)	0 0100 (4)	• • • • • • • • • •	Reboot the unit. If the problem remains the unit should be sent to service.
ERROR_CAT_VOLTAGE	Internal voltage monitoring has detected out-of-limits values for certain voltages	0 0101 (5)	• • • • • • • • • •	Reboot the unit. If the problem remains the unit should be sent to service.
ERROR_CAT_PA_CURRENT_HIGH	RF power amplifier current has exceeded the limit and the transmitter has been shut down to protect the electronics	0 0110 (6)	• • • • • • • • • •	a) Check the antenna impedance match and if needed improve the match. b) Wait for a while and restart the data transmission. If the problem remains the unit should be sent to service.
ERROR_CAT_PA_TEMP_HIGH	RF power amplifier temperature has exceeded the limit and the transmitter has been shut down to protect the electronics.	0 0111 (7)	• • • • • • • • • •	a) Check the ambient temperature. It might be too high. b) Wait for a while and restart the data transmission. If the problem remains the unit should be sent to service.

## 10. Troubleshooting

Name	Description	Code	LED	Required action
ERROR_CAT_PLL_LOCK	The RF frequency synthesizer has not been locked and either transmission or reception is not possible.	0 1000 (8)		Reboot the unit. If the problem remains the unit should be sent to service.
ERROR_CAT_RAM_CHECK	RAM memory verification failed during initialization.	0 1001 (9)		Reboot the unit. If the problem remains the unit should be sent to service.
ERROR_CAT_SW_FAILURE_1	Watchdog originated reboot because of a SW crash	0 1010 (10)		No actions required. If the same happens repeatedly the unit should be sent to service.
ERROR_CAT_SW_FAILURE_2	The SW has recognized an error and gone into error state	0 1011 (11)		Reboot the unit. If the problem remains the unit should be sent to service.
ERROR_CAT_NVM_COMM	No access to the non-volatile memory	0 1100 (12)		Reboot the unit. If the problem remains the unit should be sent to service.
ERROR_CAT_NVM_UNINITIALIZED	Non-volatile memory has entered an unformatted state due to an internal error.	0 1101 (13)		Reboot the unit. If the problem remains the unit should be sent to service.

Name	Description	Code	LED	Required action
ERROR_CAT_NVM_SETTING	Illegal value in a user or other setting.	0 1110 (14)	• • • • • •	Go through the user settings to find any illegal value. If there is not any reboot the unit. If the problem remains the unit should be sent to service.
ERROR_CAT_NVM_CORRUPT	Corrupted non-volatile memory	0 1111 (15)	• • • • • •	Reboot the unit. If the problem remains the unit should be sent to service.
ERROR_CAT_INTER_PROCESSOR_COMM	An internal communication error between MCU and DSP processors	1 0000 (16)	• • • • • •	Reboot the unit. If the problem remains the unit should be sent to service.
ERROR_CAT_INTER_SUBUNIT_COMM	Communication problem between the subunits, e.g. between the Radio and Central units.	1 0001 (17)	• • • • • •	Reboot the unit. If the problem remains the unit should be sent to service.
ERROR_CAT_SUBSYSTEM_USB_HOST	An error in USB host system	1 0010 (18)	• • • • • •	Reboot the unit. If the problem remains the unit should be sent to service.
ERROR_CAT_SUBSYSTEM_SERIAL_PORT	An error in external serial interface	1 0011 (19)	• • • • • •	Reboot the unit. If the problem remains make sure that the error is not located on the DTE. If the error seems to be in the RU it should be sent to service.

Table 10.1 Error codes by LED indication

## 10.2 Connection problems

There are some factors that may prevent proper connectivity. In general it can be said that there are usually lots of instances in network – both hardware and software – and they all have some effect to overall performance.

One instance that may prevent traffic is firewall. In example of TCP client SATELLAR tries to send TCP messages to some target device. If this device has firewall configuration, which prevents messages from a defined port, the sending of course fails. One good indicator of such case is the blinking sequence of the radio unit LEDs. Normally when sending e.g. ping message the TX LED blinks first for sending and then RX LED for receiving and same goes basically for sending TCP messages.

Even the receiving end had no application listening to messages; the sending device should be able to send messages to receiving end in proper way. If e.g. the configuration is as default - i.e. retry count is 5 and interval is 1000 milliseconds - LEDs in radio unit should blink 5 times with 1 second interval in such case where no application receives them. This means that SATELLAR is able to communicate with TCP stack of target device even though no application actually receives the messages. Other options are e.g. to investigate the traffic with Wireshark or to check the ports with netcat (nc).

But in case the LED blinking is not as systematic as described but instead more incoherent and the interval tends to get longer, there may be an issue with target device firewall. In such case the target device firewall configuration should be investigated.

As a summary couple of rules of thumb:

- Sending of messages to target must succeed even though there is no application listening to them. This can be observed by e.g. LED blinking.
- Target device must have the defined ports opened in firewall for communication.
- Ping is a good tool for diagnostics in network, but even though ping succeeds between the devices, it does not ensure that all other communication is available. There are different tools - such as netcat - that check the status of defined ports.

# 11. Settings selection guide

## 11.1 Modem Settings

3

Menu	Submenu	Value (* = default)	
<b>Network Protocol Mode</b>	NetID	Satel NG * (max 8 characters)	
	Address (RMAC)	0001 * (1 - 4093)	
	Protocol Mode		Basic-RX Priority
			Basic-TX Priority
			Basic-Repeater
			Packet Routing * <span style="float: right;">Source</span>
		Routing, master <span style="float: right;">Source Routing, slave</span>	
Network Size support	0=Small network (up to 150 modems) 1= Large network (up to 4000 modems)		
<b>Radio</b>	TX Frequency	460.000000 MHz (Depends on hardware configuration)	
	RX Frequency	460.000000 MHz (Depends on hardware configuration)	
	RF Output Power	FSK-radio: 0.1, 0.2, 0.3, 0.4, 0.5, 1, 2 and 5 W * QAM-radio: 0.1, 0.2, 0.5, 1, 2 and 5 W * (Peak power values)	
	Signal Threshold	FSK: -118 dBm. Adjustable in the range of -80 ... -127 dBm QAM: -110dBm. Adjustable in the range of -80 ... -110 dBm	
	Over the-Air Encryption	OFF * / ON	
	Forward Error Correction Coding	Trellis OFF * / ON <span style="float: right;">OFF * / ON</span>	
	Channel Spacing	FSK-radio: 12.5, 25 *, 150 kHz QAM-radio: 6.25, 12.5, 25 * kHz	
	Air Speed / FSK-radio	12.5 kHz    25 kHz    150 kHz	
	4-FSK	9600 bps    19200 bps    115200 bps	
	8-FSK	14400 bps    28800 bps    172800 bps	
	16-FSK	19200 bps    38400 bps    230400 bps	
	Air Speed / QAM-radio	6.25 kHz    12.5 kHz    25 kHz	
	2-QAM	4680 bps    10080 bps    20160 bps	
	4-QAM	9360 bps    20160 bps    40320 bps	
	8-QAM	14040 bps    30240 bps    60480 bps	
16-QAM	18720 bps    40320 bps    80640 bps		
32-QAM	23400 bps    50400 bps    100800 bps		
64-QAM	28080 bps    60480 bps    120960 bps		

## 11. Settings selection guide

Menu	Submenu	Value (* = default)
<b>Serial Connector Configuration</b>	Radio Unit Port	NONE
	Assignment	DATA UART TO RADIO D9 RD/TD
		DATA UART TO RADIO D9 RD/TD - NMS TO D9 DTR/DSR
		DATA UART TO RADIO D9 RD/TD - NMS TO D9 RTS/CTS
		DATA UART TO RADIO D9 RD/TD - NMS TO SATBUS MCU UARTS TO SATBUS WITH CAN *
DTE Port Physical Communication Mode	RS-232, RS-422, RS-485, FD-RS-485	
<b>Data Port Settings 1)</b>	Rate	9600 * (1200 - 460800) bps
	Data Bits	7, 8 * bits
	Parity	No Parity Check *, Even, Odd
	Stop Bits	1 *, 2 bits
<b>Serial Data Flow Control</b>	TX Delay	0 * (0 - 65535)
	CRC	OFF / ON *
	Handshaking CTS Line	Clear To Send, TX buffer state *, RSSI Threshold, Always ON
	Handshaking RTS Line	Ignored *, Flow control, Reception control
	Handshaking CD Line	RSSI threshold *, Data on channel, Always ON
	Pause Length	3 bytes * (3 - 255)
	Maximum Number of Accepted Errors	0 * (0 - 255)
<b>Packet Mode Radio Access Control</b>	Network Topology / Handshake	Point-to-point *, Repeater, Fast mode / ON, OFF
	Retransmissions	OFF / ON *
	Back Off Counter	8 * (4 - 63)
	Packet Expiration Time	0 (ms)

NOTE! The Fast Mode selection is not available with 150 kHz channel.

1) See further details from section 5.1 Serial data, page 24

SATEL Oy  
Meriniitynkatu 17, P.O.Box 142  
FI-24101 Salo, Finland  
Tel. +358 2 777 7800  
info@satel.com  
[www.satel.com](http://www.satel.com)

**MISSION-CRITICAL CONNECTIVITY**

**SATEL**