

## IMPORTANT NOTICE

All rights to this manual are owned solely by SATEL OY (referred to in this user guide as SATEL). All rights reserved. The copying of this manual (without the written permission from the owner) by printing, copying, recording or by any other means, or the full or partial translation of the manual to any other language, including all programming languages, using any electrical, mechanical, magnetic, optical, manual or other methods or devices is forbidden.

SATEL reserves the right to change the technical specifications or functions of its products, or to discontinue the manufacture of any of its products or to discontinue the support of any of its products, without any written announcement and urges its customers to ensure, that the information at their disposal is valid.

SATEL software and programs are delivered "as is". The manufacturer does not grant any kind of warranty including guarantees on suitability and applicability to a certain application. Under no circumstances is the manufacturer or the developer of a program responsible for any possible damages caused by the use of a program. The names of the programs as well as all copyrights relating to the programs are the sole property of SATEL. Any transfer, licensing to a third party, leasing, renting, transportation, copying, editing, translating, modifying into another programming language or reverse engineering for any intent is forbidden without the written consent of SATEL.

**SATEL PRODUCTS HAVE NOT BEEN DESIGNED, INTENDED NOR INSPECTED TO BE USED IN ANY LIFE SUPPORT RELATED DEVICE OR SYSTEM RELATED FUNCTION NOR AS A PART OF ANY OTHER CRITICAL SYSTEM AND ARE GRANTED NO FUNCTIONAL WARRANTY IF THEY ARE USED IN ANY OF THE APPLICATIONS MENTIONED.**

Salo, FINLAND 2012

## RESTRICTIONS ON USE

SATELLINE-3AS(d) radio modems have been designed to operate on frequency ranges, the exact use of which differs from one region and/or country to another. The user of a radio modem must take care that the said device is not operated without the permission of the local authorities on frequencies other than those specifically reserved and intended for use without a specific permit.

**SATELLINE-3AS(d)** (330...470 MHz) is allowed to be used in the following countries, either on licence free channels or on channels where the operation requires a licence. More detailed information is available at the local frequency management authority.

Countries\*: AT, AU, BE, BR, CA, HR, CZ, CY, DK, EE, FI, FR, DE, GR, HK, HU, ID, IS, IE, IL, IT, KR\*<sup>1</sup>, LV, LT, MY, MX, NL, NO, OM, PL, PT, RO, RU, SG, SK, ZA, ES, SE, CH, TH, TR, UA, GB, US and VN.

\*<sup>1</sup> Special version for Korea available.

**SATELLINE-3AS(d) 869 MHz** is designed to operate in the following countries listed below on the licence free frequency band of 869.400 – 869.650 MHz (not incorporating the band 869.300 – 869.400 MHz) according to recommendation CEPT/ERC/REC 70-03. This recommendation has been drawn up by the European Radiocommunication Committee (ERC) under CEPT. The transmit/receive duty cycle of the individual unit is limited to 10% on this band, and a single transmission period must not exceed 36 s. In addition, the maximum allowed radiated output power is 500 mW<sub>ERP</sub>.

Countries\*: AT, BE, HR, DK, EE, FI, FR, DE, GR, HU, IS, IE, IT, NL, NO, PL, PT, SG, SK, ZA, ES, SE, CH, TR and GB.

\*<sup>2</sup> Max. ERP 10 mW

SATELLINE-3AS(d) Epic is allowed to be used in the following countries, either on licence free channels or on channels where the operation requires a licence. More detailed information is available at the local frequency management authority.

Countries\*: AT, AU, BE, CA, HR, DK, EE, FI, FR, DE, GR, HU, ID, IS, IE, IL, IT, LT, LV, MY, NL, NO, OM, PL, PT, RO, RU, ZA, ES, SK, SE, CH, TH, TR, UA, GB, US and VN

**WARNING!** Users of SATELLINE-3AS(d) and Epic radio modems in North America should be aware, that due to the allocation of the frequency band 406.0 – 406.1 MHz for government use only, the use of radio modem on this frequency band without a proper permit is strictly forbidden.

In addition project approvals available for IN, KZ and TW.

\* codes of the countries follow the ISO 3166-1-Alpha-2 standard

## PRODUCT CONFORMITY

### SATELLINE-3AS(d)

Hereby, SATEL Oy declares that SATELLINE-3AS(d) radio modem is in compliance with the essential requirements (radio performance, electromagnetic compatibility and electrical safety) and other relevant provisions of Directive 1999/5/EC. Therefore the equipment is labelled with the following CE-marking. The notification sign informs user that the operating frequency range of the device is not harmonised throughout the market area, and the local spectrum authority should be contacted before the usage of the radio modem.



### DECLARATION of CONFORMITY

In Accordance with  
1999/5/EC Directive

of the European Parliament and of the Council of 9 March 1999 on radio equipment and telecommunications terminal equipment and the mutual recognition of their conformity

Doc No:	SATEL-DC-RTTE-091		
Manufacturer:	SATEL Oy		
Address:	POB 142, (Meriniitykatu 17), 24101 Salo, Finland		
Products :	Type	Model	
	SATELLINE-3AS/125 SATELLINE-3AS/200 SATELLINE-3AS/250	SATELLINE-3AS SATELLINE-3AS DB SATELLINE-3AS NMS SATELLINE-3AS NMS DB	Radio Modem Radio Modem Radio Modem Radio Modem
	SATELLINE-3ASd/125 SATELLINE-3ASd/200 SATELLINE-3ASd/250	SATELLINE-3ASd SATELLINE-3ASd DB SATELLINE-3ASd NMS SATELLINE-3ASd NMS DB	Radio Modem Radio Modem Radio Modem Radio Modem
	SATELLINE-3AS-PT/125 SATELLINE-3AS-PT/200 SATELLINE-3AS-PT/250	SATELLINE-3AS-PT	Radio Modem
	SATELLINE-3AS-AG/125 SATELLINE-3AS-AG/200 SATELLINE-3AS-AG/250	SATELLINE-3AS-AG	Radio Modem

Notified Body Opinion: according to: Annex IV of R&TTE Directive  
Document Nr: 153302N  
Issued by: Nemko Oy  
Dated On: 12.07.2010  
Notified Body: Nr. 1987

We, the manufacturer of the above mentioned products, hereby declare that these products conform to the essential requirements of the European Union directive 1999/5/EC. This Declaration of Conformity is based on the following documents:

Doc. No	Type of Product	Test Specification	Laboratory / Date of Issue
TL 990313	-3ASd/125	ETS 300 113-2 <sup>nd</sup> Ed 1996	EMCEC / Espoo 29.02.2000
TL 1000461	-3ASd/250	ETS 300 113-2 <sup>nd</sup> Ed 1996	EMCEC / Espoo 29.02.2000
TL 980212	-3ASd/250	EN 300 220-1 V1.2.1	EMCEC / Espoo 07.10.1998
200212216	-3ASd/125	IEC 60950-1:2001	NEMKO / Oulu 22.03.2002
200212216	-3ASd/250	IEC 60950-1:2001	NEMKO / Oulu 22.03.2002
1031925	-3ASd/250	EN 301 489-1 V1.4.1, -5 V1.3.1	NEMKO / Espoo 30.10.2003
1032532	-3ASd/200	EN 300 113-2 V1.3.1	NEMKO / Espoo 23.11.2004
99909	-3ASd/125/250	EN 300 113-2 V1.4.1	NEMKO / Espoo 18.1.2008
152137	-3ASd/125/250	EN 300 113-2 V1.4.1	NEMKO / Espoo 15.6.2010

Based on the fact that the technical requirements have not changed between the standards ETS 300 113 and EN 300 113-2, as well as EN 300 220-1 and -3, we therefore declare the full conformity to the standards EN 300 113-2 and EN 300 220 -3.

Salo on the 22<sup>nd</sup> of October, 2010.

SATEL OY  
Peikka Auro  
CEO



SATEL Oy  
PO Box 142, FI-24101 SALO, FINLAND  
Street: Meriniitykatu 17, FI-24100 SALO, FINLAND  
Tel. +358 2 777 7800, Fax +358 2 777 7810  
E-mail: info@satel.com, www.satel.com

## SATELLINE-3AS(d) Epic

Hereby, SATEL Oy declares that SATELLINE-3AS(d) Epic radio modem is in compliance with the essential requirements (radio performance, electromagnetic compatibility and electrical safety) and other relevant provisions of Directive 1999/5/EC. Therefore the equipment is labelled with the following CE-marking. The notification sign informs user that the operating frequency range of the device is not harmonised throughout the market area, and the local spectrum authority should be contacted before the usage of the radio modem.



### DECLARATION of CONFORMITY

In Accordance with  
1999/5/EC Directive

of the European Parliament and of the Council of 9 March 1999 on radio equipment and telecommunications terminal equipment and the mutual recognition of their conformity

Doc No: SATEL-DC-RTTE-090  
Manufacturer: SATEL Oy  
Address: P.O. Box 142, (Meriniitynkatu 17), FI-24101 Salo, Finland

Products :	Type	Model
<b>SATEL-TA3</b>		SATELLINE-3AS Epic
		SATELLINE-3AS Epic C
		SATELLINE-3AS Epic DB
		SATELLINE-3AS Epic C DB
		SATELLINE-3AS Epic NMS
<b>SATEL-TA8</b>		SATELLINE-3AS Epic C NMS
		SATELLINE-3AS Epic NMS DB
		SATELLINE-3AS Epic C NMS DB
		SATELLINE-3ASd Epic
		SATELLINE-3ASd Epic C
<b>SATEL-TA4</b>		SATELLINE-3ASd Epic DB
		SATELLINE-3ASd Epic C DB
		SATELLINE-3ASd Epic NMS
		SATELLINE-3ASd Epic C NMS
		SATELLINE-3ASd Epic NMS DB
		SATELLINE-3ASd Epic C NMS DB
		SATELLINE-3ASd Epic Pro
		SATELLINE-3ASd Epic Pro, Sakkia

Radio Modem

Notified Body Opinion: according to: Annex IV of R&TTE Directive  
Document Nr: 153300N  
Issued by: Nemko Oy  
Dated On: 12.07.2010  
Notified Body Nr. 1987

We, the manufacturer of the above mentioned products, hereby declare that these products conform to the essential requirements of the European Union directive 1999/5/EC. This Declaration of Conformity is based on the following documents:

Doc. No	Type of Product	Test Specification	Laboratory / Date of Issue
77819	SATEL-TA4, -TA3, -TA8	EN 300 113-2 V1.3.1	NEMKO / Espoo 20.6.2007
778215	SATELLINE-3ASd Epic	Attestation with regard to Annex I, 3.2.9.	NEMKO / Espoo 20.11.2006
90857A	SATEL-TA4	EN 301 489-1, -5	NEMKO / Espoo 31.8.2007
90857B	SATEL-TA4	Commission Directive 2004/104/EC	NEMKO / Espoo 31.8.2007
77829	SATEL-TA4	EH 60950-1	NEMKO / Espoo 11.9.2007
148349	SATEL-TA4	EN 300 113-2 V1.3.1	NEMKO / Espoo 28.5.2010

Salo on the 22<sup>nd</sup> of October, 2010

SATEL OY  
Pekka Aura  
CEO

SATEL Oy  
P.O. Box 142, FI-24101 SALO, FINLAND  
Street: Meriniitynkatu 17, FI-24100 SALO, FINLAND  
Tel. +358 2 777 7800, Fax +358 2 777 7810  
E-mail: info@satel.com, www.satel.com

**SATEL**<sup>®</sup>  
WIRELESS WORLD - LOCAL SOLUTION

## SATELLINE-3AS(d) 869

Hereby, SATEL Oy declares that SATELLINE-3AS(d) radio modem is in compliance with the essential requirements (radio performance, electromagnetic compatibility and electrical safety) and other relevant provisions of Directive 1999/5/EC. Therefore the equipment is labelled with the following CE-marking.

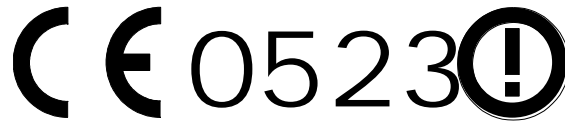

### DECLARATION of CONFORMITY

In Accordance with  
1999/5/EC Directive

of the European Parliament and of the Council of 9 March 1999 on radio equipment and telecommunications terminal equipment and the mutual recognition of their conformity

Doc No: SATEL-DC-RTTE-065  
Manufacturer: SATEL Oy  
Address: POB 142, ( Meriniitynkatu 17 ), 24101 Salo, Finland

Products :	Type	Model
	<b>SATELLINE-3AS/869</b>	<b>SATELLINE-3AS 869</b> Radio Modem
	<b>SATELLINE-3ASd/869</b>	<b>SATELLINE-3ASd 869</b> Radio Modem

Notified Body Opinion: according to: Annex IV of R&TTE Directive  
Document Nr: FI07700020  
Issued by: Finnish Communications Regulatory Authority  
Dated On: 4<sup>th</sup> of December, 2007  
Notified Body: Nr. 0523

We, the manufacturer of the above mentioned products, hereby declare that these products conform to the essential requirements of the European Union directive 1999/5/EC. This Declaration of Conformity is based on the following documents:

Doc. No	Type of Product	Test Specification	Laboratory / Date of Issue
200212216	SATELLINE-3ASd/869	IEC 60950, 3 <sup>rd</sup> Edition	NEMKO / Espoo 22.3.2002
88272	SATELLINE-3AS/869	EN 300 220-2 V2.1.1	NEMKO / Espoo 23.05.2007
92845A	SATELLINE-3AS/869	EN 301 489-1&3	NEMKO / Espoo 07.09.2007

Based on the fact that the technical requirements have not changes between the standards EN 300 220-1 and -3, we therefore declare the full conformity to the standard 300 220-3.

Salo on 4<sup>th</sup> of January, 2008.

SATEL OY

Tuomas Pitkönen  
Managing Director

*Tuomas Pitkönen*

SATEL OY, P.O.Box 142, FI-24101 SALO, FINLAND  
Street: Meriniitynkatu 17, FI-24100 SALO, FINLAND  
Tel +358 2777 7800, Fax +358 2 777 7810, E-mail info@satel.com  
www.satel.com



## WARRANTY AND SAFETY INSTRUCTIONS

Read these safety instructions carefully before using the product:

- Warranty will be void, if the product is used in any way that is in contradiction with the instructions given in this manual, or if the radio modem housing has been opened or tampered with.
- The radio modem is only to be operated at frequencies allocated by local authorities, and without exceeding the given maximum allowed output power ratings. SATEL and its distributors are not responsible, if any products manufactured by it are used in unlawful ways.
- The devices mentioned in this manual are to be used only according to the instructions described in this manual. Faultless and safe operation of the devices can be guaranteed only if the transport, storage, operation and handling of the devices is appropriate. This also applies to the maintenance of the products.
- To prevent damage both the radio modem and any terminal devices must always be switched OFF before connecting or disconnecting the serial connection cable. It should be ascertained that different devices used have the same ground potential. Before connecting any power cables the output voltage of the power supply should be checked.

## TABLE OF CONTENTS

<b>IMPORTANT NOTICE</b> .....	<b>1</b>
<b>RESTRICTIONS ON USE</b> .....	<b>2</b>
<b>PRODUCT CONFORMITY</b> .....	<b>3</b>
<b>WARRANTY AND SAFETY INSTRUCTIONS</b> .....	<b>6</b>
<b>TABLE OF CONTENTS</b> .....	<b>7</b>
<b>INTRODUCTION</b> .....	<b>12</b>
<b>1 SATELLINE-3AS(D) / 869 / EPIC RADIO DATA MODEMS</b> .....	<b>13</b>
1.1 SATELLINE-3AS(d) technical specifications (330...470 MHz).....	13
1.2 SATELLINE-3AS(d) 869 technical specifications .....	14
1.3 SATELLINE-3AS(d) Epic techn. specs (330...470 MHz).....	15
1.4 <b>Basic configuration and installation</b> .....	<b>16</b>
1.4.1 Prepare installation of SATELLINE-3AS(d) modem into the SATEL-321 casing.....	18
<b>2 SERIAL INTERFACE</b> .....	<b>19</b>
2.1 D15 connector .....	20
2.2 RS-232 interface .....	21
2.3 RS-422 interface .....	22
2.4 RS-485 interface .....	23
2.5 Termination of RS-422/485 lines .....	23
<b>3 RF INTERFACE</b> .....	<b>24</b>
3.1 Transmitter .....	24
3.2 Receiver .....	25
3.2.1 RSSI-signal .....	26
3.3 Priority RX/TX.....	27
3.4 Error correction .....	27

<b>3.5</b>	<b>Error checking</b> .....	<b>28</b>
<b>3.6</b>	<b>Dual Band version</b> .....	<b>28</b>
<b>3.7</b>	<b>Dual Channel function</b> .....	<b>29</b>
<b>3.8</b>	<b>Free Channel Scan (FCS) function</b> .....	<b>30</b>
<b>3.9</b>	<b>User data whitening</b> .....	<b>31</b>
<b>3.10</b>	<b>Pacific Crest and TRIMTALK compatibility</b> .....	<b>31</b>
3.10.1	General.....	31
3.10.2	Configuration in Programming menu .....	31
3.10.3	Configuration by using SL commands.....	32
3.10.4	Settings.....	32
3.10.5	Repeater function .....	34
3.10.6	Support for Local / Remote addresses .....	34
3.10.7	Latency .....	35
3.10.7.1	Transmission delays using Option 1 (Pacific Crest 4FSK) on 25 kHz channel.....	35
3.10.7.2	Transmission delays using Option 2 (Pacific Crest GMSK) on 25 kHz channel.....	36
<b>4</b>	<b>USER INTERFACE</b> .....	<b>37</b>
<b>4.1</b>	<b>LED-indicators</b> .....	<b>37</b>
<b>4.2</b>	<b>Programming Mode</b> .....	<b>37</b>
4.2.1	Changing the settings .....	38
4.2.2	Restoring factory settings .....	39
<b>4.3</b>	<b>Display and push buttons (SATELLINE-3ASd and -3ASd Epic)</b> .....	<b>39</b>
<b>5</b>	<b>TRANSPARENT DATA TRANSMISSION</b> .....	<b>41</b>
<b>5.1</b>	<b>Serial interface, data format</b> .....	<b>41</b>
<b>5.2</b>	<b>Handshake lines</b> .....	<b>42</b>
5.2.1	CTS-line .....	42
5.2.2	CD-line .....	42
5.2.3	RTS-line.....	43
<b>5.3</b>	<b>Timing and delays during data transmission</b> .....	<b>43</b>
5.3.1	Data buffering in the radio data modem.....	43
5.3.2	Pause length .....	44
5.3.3	TX delay.....	45
<b>5.4</b>	<b>Tests</b> .....	<b>45</b>
<b>6</b>	<b>REPEATER MODE AND ADDRESSING</b> .....	<b>47</b>
<b>6.1</b>	<b>Repeater</b> .....	<b>47</b>

<b>6.2 Addressing</b> .....	<b>48</b>
6.2.1 Connection between two points .....	50
6.2.2 System of one base station and several substations .....	50
<b>6.3 Using repeaters and addresses in the same system</b> .....	<b>51</b>
6.3.1 System with several repeaters .....	51
6.3.2 Repeater chain using address pairs .....	52
6.3.3 Repeater chain using dual addressing .....	53
6.3.4 Redundant repeater chain .....	53
<b>7 MESSAGE ROUTING</b> .....	<b>54</b>
<b>7.1 Introduction to Message Routing</b> .....	<b>54</b>
7.1.1 Features of Message Routing .....	55
7.1.2 Limitations of Message Routing .....	55
7.1.3 Getting started with Message Routing .....	55
7.1.4 SaTerm and the configuration of the Message Routing .....	56
7.1.5 Manual configuration of the Message Routing .....	56
7.1.6 Configuration of the protocol in Message Routing .....	57
<b>7.2 Operating modes of Message Routing</b> .....	<b>58</b>
<b>7.3 Detailed description of Message Routing</b> .....	<b>59</b>
7.3.1 Source Mode Routing .....	59
7.3.2 Virtual Mode Routing .....	59
7.3.3 Overhop function in Source Mode Routing .....	59
7.3.4 Network ID .....	61
<b>8 DIVERSITY RECEIVER SATELLINE-3AS(D) EPIC</b> .....	<b>62</b>
<b>8.1 Multipath fading</b> .....	<b>62</b>
<b>8.2 Antenna installation</b> .....	<b>63</b>
<b>9 SETTINGS</b> .....	<b>64</b>
<b>9.1 Changing parameters using a terminal device</b> .....	<b>64</b>
9.1.1 Changing frequency (active radio channel frequency) .....	65
9.1.2 Changing radio settings .....	66
9.1.3 Changing addressing settings (primary and secondary RX- and TX-addresses) .....	68
9.1.4 Modification of handshaking functions .....	73
9.1.5 Special functions .....	75
9.1.6 Modification of routing .....	76
9.1.7 Activating tests .....	80
9.1.8 Restoring factory settings .....	80
9.1.9 Saving modified settings into the permanent memory .....	80
9.1.10 Updating software .....	81
<b>9.2 Changing parameters using the LCD-display</b> .....	<b>81</b>

9.2.1	Changing frequency (frequency of the active radio channel)	82
	Changing radio settings (transmitter power and receiver sensitivity)	84
9.2.2	Changing addressing	85
9.2.3	Changing serial port settings (Port 1 and Port 2)	86
9.2.4	Modification of handshaking functions	87
9.2.5	Selecting special functions	88
9.2.6	Activating tests	88
9.2.7	Restoring factory settings	89
9.2.8	Adjusting the contrast of the LCD-display	89
9.2.9	Saving modified values into the internal memory	90
<b>9.3</b>	<b>Changing parameters using the SL-COMMANDS</b>	<b>90</b>
9.3.1	Frequency	91
9.3.2	Addressing	92
9.3.3	Radio parameters	93
9.3.4	Other functions	94
<b>10</b>	<b>INSTALLATION</b>	<b>97</b>
<b>10.1</b>	<b>Installation of a radio data modem</b>	<b>97</b>
<b>10.2</b>	<b>Connection cables</b>	<b>98</b>
10.2.1	RS-232 wiring	98
10.2.2	RS-422 wiring	100
10.2.3	RS-485 wiring	101
10.2.4	Fuse	102
10.2.5	Power supply	102
<b>10.3</b>	<b>Antenna installation</b>	<b>103</b>
10.3.1	Hand-held equipment	103
10.3.2	Mobile equipment	103
10.3.3	Base stations	103
10.3.4	General antenna installation instructions	104
<b>11</b>	<b>DESIGNING SYSTEMS</b>	<b>107</b>
<b>11.1</b>	<b>Factors affecting the quality and distance of the radio connection</b>	<b>107</b>
<b>11.2</b>	<b>Radio field strength</b>	<b>108</b>
<b>11.3</b>	<b>Remarks concerning the 869 MHz frequency band</b>	<b>108</b>
<b>12</b>	<b>CHECK LIST</b>	<b>109</b>
<b>13</b>	<b>ACCESSORIES</b>	<b>110</b>
<b>13.1</b>	<b>RS-232 cables and adapters</b>	<b>110</b>
<b>13.2</b>	<b>RS-485/422 cables and adapters</b>	<b>110</b>

<b>13.3</b>	<b>RF-cables</b> .....	<b>110</b>
<b>13.4</b>	<b>Antennas</b> .....	<b>111</b>
<b>13.5</b>	<b>Filters and lightning protectors</b> .....	<b>111</b>
<b>13.6</b>	<b>Power supplies</b> .....	<b>111</b>
<b>13.7</b>	<b>Battery pack</b> .....	<b>111</b>
<b>13.8</b>	<b>Installation and enclosures</b> .....	<b>111</b>
<b>14</b>	<b>APPENDIX A</b> .....	<b>112</b>
<b>15</b>	<b>APPENDIX B</b> .....	<b>113</b>
<b>15.1</b>	<b>Functional delays</b> .....	<b>113</b>
<b>15.2</b>	<b>Transmission related delays</b> .....	<b>113</b>
15.2.1	Transmission delays when using a 12.5 kHz radio channel.....	114
15.2.2	Transmission delays using a 25 kHz radio channel .....	116

## INTRODUCTION

SATEL OY is a Finnish electronics and Telecommunications Company specialising in the design and manufacture of wireless data communication products. SATEL designs, manufactures and sells radio modems intended for use in applications ranging from data transfer to alarm relay systems. End users of SATEL products include both public organisations and private individuals.

SATEL is the leading European manufacturer of radio modems. SATEL radio modems have been certified in most European countries and also in many non-European countries.

Both the amount of data transferred, and the size of local area networks is increasing constantly. The SATELLINE-3AS can offer speeds up to 19.2 kbps and has a selectable serial interface speed between 300 ... 38 400 bps. SATELLINE-3AS also offers many other useful features. These include built-in support for RS-422 and RS-485 interfaces as well as the standard RS-232 interface.

The SATELLINE-3ASd and SATELLINE-3ASd Epic models include a built-in LCD display, offering the user both new features and increased flexibility. No longer do you have to rely on access to a PC or terminal device to check or alter the configuration of the unit, now this can be achieved by viewing the LCD-display and using the four (4) push buttons. The display is also a useful tool in testing the radio connection between radio modems.

SATELLINE-3AS facilitates the construction of large radio networks using the built-in *Message Routing* function, which is both fully transparent to the user and can be used with most system protocols. SATELLINE-3AS also offers option of error correction, utilising the FEC-method (Forward Error Correction). FEC can be used to minimise errors caused by noisy channels.

SATELLINE-3AS radio modem operates in one of the 4 basic modes of operation: *Data Transfer Mode, Programming Mode, Test Mode* or *Standby Mode*.

**NOTE!** This user guide version 3.4 is compatible with the radio modems marked with text "E2-PF" on the serial number label and having software version 3.39 or later.

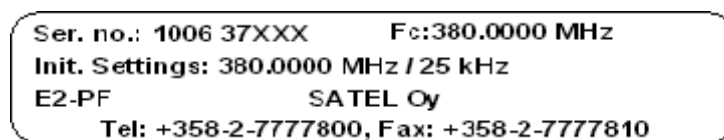

**NOTE2!** The software versions starting from number 3.00 apply for SATELLINE-3AS(d) radio modems labeled with "E2" marking. The name extension of the flash files is .sf2.

The software versions 0.xx...2.xx apply for the radio modems which do NOT have the marking "E2" on the label. The name extension of the flash files is .sff.

# 1 SATELLINE-3AS(d) / 869 / Epic RADIO DATA MODEMS

## 1.1 SATELLINE-3AS(d) technical specifications (330...470 MHz)

SATELLINE-3AS(d) (330...470 MHz) comply with the following international standards: EN 300 113-1, -2 and EN 300 220-1, -3 (radio), EN 301 489-1, -5 (EMC) and IEC 60950-1 (safety) and FCC part 90.

### RADIO TRANSCEIVER

Frequency Range	330...470 MHz
Tuning Range	$\pm 2$ MHz from central frequency
Channel Spacing	12.5 kHz / 20 kHz / 25 kHz
Number of Channels	320 / 200 / 160 (or 2 x 160/100/80) * <i>Note 1</i>
Frequency Stability	$< \pm 1.5$ kHz
Type of Emission	F1D
Communication Mode	Half-Duplex

### RADIO TRANSMITTER

Carrier Power	10 mW...1 W / 50 ohm
Carrier Power Stability	+ 2 dB / - 3 dB
Adjacent Channel Power	according to EN 300 220-1/EN 300 113-1
Spurious Radiation	according to EN 300 220-1/EN 300 113-1

### RADIO RECEIVER

Sensitivity	- 115... -110 dBm (BER < 10 E-3) * <i>Note 2</i>
Common Channel Rejection	> - 12 dB
Adjacent Channel Selectivity	> 60 dB @ 12,5 kHz, > 70 dB @ 25 kHz
Intermodulation Attenuation	> 65 dB
Spurious Radiation	< 2 nW

### MODEM

Interface	RS-232 or RS-485, RS-422
Interface Connector	D15, female
Data Speed of Serial Interface	300 – 38400 bps
Data Speed of Radio Interface	19200 bps @ 25 kHz, 9600 bps @12.5/20 kHz
Data format	Asynchronous RS-232 or RS-422 or RS-485

### GENERAL

Operating Voltage	+ 9 ... + 30 V <sub>DC</sub>
Power Consumption (average)	1.1 W (Receive), 5 W (Transmit) 0.05 W (in <i>Standby Mode</i> )
Operating Temperature Range	-25 °C...+55 °C -40 °C...+75 °C (absolute min / max)
Storage Temperature Range	-40 °C...+85 °C
Antenna Connector	TNC, 50 ohm, female
Housing	Aluminium enclosure
Size H x W x D	137 x 67 x 29 mm
Installation Plate	130 x 63 x 1 mm
Weight	260 g

\* *Note 1*: The Dual Band version operates on two separate 2 MHz wide frequency bands.

\* *Note 2*: Depending on Receiver settings, see Chapters 3.2, 9.1.2 and 9.2.2.

## 1.2 SATELLINE-3AS(d) 869 technical specifications

SATELLINE-3AS(d) 869 comply with the following international standards: EN 300 220-1, -2 (radio), EN 301 489-1, -3 (EMC) and IEC 60950 (safety).

### RADIO TRANSCEIVER

Frequency Range	869.4125 ... 869.6375 MHz
Channel Spacing	25 kHz
Number of Channels	10
Frequency Stability	< $\pm$ 2.5 kHz
Type of Emission	F1D
Communication Mode	Half-Duplex

### RADIO TRANSMITTER

Carrier Power	10 mW...500 mW / 50 ohm
Carrier Power Stability	+ 2 dB / - 3 dB
Adjacent Channel Power	according to EN 300 220-1
Spurious Radiation	according to EN 300 220-1

### RADIO RECEIVER

Sensitivity	-108 dBm (BER < 10 E-3) *
Common Channel Rejection	> - 12 dB
Adjacent Channel Selectivity	> 60 dB
Intermodulation Attenuation	> 60 dB
Spurious Radiation	< 2 nW

### MODEM

Interface	RS-232 or RS-485, RS-422
Interface Connector	D15, female
Data speed of RS-Interface	300 – 38400 bps
Data speed of Radio Interface	19200 bps (25 kHz channel)
Data format	Asynchronous RS-232 or RS-422 or RS-485

### GENERAL

Operating Voltage	+ 9 ... + 30 V <sub>DC</sub>
Power Consumption (average)	1.2 W (Receive), 3.6 W (Transmit) 0.05 W (in <i>Standby Mode</i> )
Operating Temperature Range	-25 °C...+55 °C -40 °C...+75 °C (absolute min / max)
Storage Temperature Range	-40 °C...+85 °C
Antenna Connector	TNC, 50 ohm, female
Housing	Aluminium enclosure
Size H x W x D	137 x 67 x 29 mm
Installation Plate	130 x 63 x 1 mm
Weight	260 g

\* Depending on Receiver settings, see Chapters 3.2, 9.1.2 and 9.2.2.

### 1.3 SATELLINE-3AS(d) Epic techn. specs (330...470 MHz)

SATELLINE-3AS(d) Epic (330...470 MHz) complies with the following international standards: EN 300 113-2 (radio), EN 301 489-1, -5 (EMC) and EN 60950-1 (safety) and FCC part90.

#### RADIO TRANSCEIVER

Frequency Range	330...470 MHz
Tuning Range	$\pm 2$ MHz from central frequency
Channel Spacing	12.5 kHz / 20 kHz / 25 kHz
Number of Channels	320 / 200 / 160 (or 2 x 160/100/80) * <i>Note 1</i>
Frequency Stability	$< \pm 1.5$ kHz
Type of Emission	F1D
Communication Mode	Half-Duplex

#### RADIO TRANSMITTER

Carrier Power	1, 2, 5 or 10 W / 50 ohm
Carrier Power Stability	+ 2 dB / - 3 dB
Adjacent Channel Power	according to EN 300 113-1
Spurious Radiation	according to EN 300 113-1

#### RADIO RECEIVER

Sensitivity	- 115... -110 dBm (BER < 10 E-3) * <i>Note 2</i>
Common Channel Rejection	> - 12 dB
Adjacent Channel Selectivity	> 60 dB @ 12.5 kHz, > 70 dB @ 25 kHz
Intermodulation Attenuation	> 65 dB
Spurious Radiation	< 2 nW
Diversity Scheme	Space / polarization diversity, selection combining

#### MODEM

Interface	RS-232 or RS-485, RS-422
Interface Connector	D15, female
Data Speed of Serial Interface	300 – 38400 bps
Data Speed of Radio Interface	19200 bps (25 kHz channel) 9600 bps (12.5 kHz channel)
Data format	Asynchronous RS-232 or RS-422 or RS-485

#### GENERAL

Operating Voltage	+ 11.8... + 30 V <sub>DC</sub>
Power Consumption (average)	1.6 W (Receive), 32 W (Transmit) 0.1 W (in <i>Standby Mode</i> )
Operating Temperature Range	-25 °C... +55 °C -40 °C... +75 °C (absolute min / max)
Storage Temperature Range	-40 °C... +85 °C
Antenna Connector	TNC, 50 ohm, female
Housing	Aluminium enclosure
Size H x W x D	151 x 123 x 29 mm
Weight	580 g (without additional cooling parts) 1520 g (with cooling part)

\* *Note 1*: The Dual Band version operates on two separate 2 MHz wide frequency bands.

\* *Note 2*: Depending on Receiver settings, see Chapters 3.2, 9.1.2 and 9.2.2.

## 1.4 Basic configuration and installation

The radio modem is shipped with the following default settings (unless otherwise specifically ordered):

FIXED SETTINGS DEFINED AT THE TIME OF ORDER	
Radio Frequency Range	In accordance with Customer Order and taking into account the regulations set by the local authorities, between 330–470 MHz (3AS and Epic) or 869.4125-869.6375 MHz (3AS 869)
Channel Spacing	12.5, 20 or 25 kHz apart from the 869 MHz which must be 25 kHz

ADJUSTABLE SETTINGS	
Radio Settings	1 W (3AS), 10 W (Epic), 500mW (3AS 869) / -112 dBm @ 25 kHz or -114 dBm @ 12.5 kHz / Diversity mode OFF (applies to Epic)
Addressing	RX Address OFF / TX Address OFF
Serial Port 1	ON / 19200 / 8 bit data / None / 1 stop bit for 12.5 kHz the default data speed is 9600 bps
Serial Port 2	OFF / 19200 / 8 bit data / None / 1 stop bit for 12.5 kHz the default data speed is 9600 bps
Handshaking	CTS Clear to send / CD RSSI-threshold / RTS Ignored
Additional settings	Error Correction OFF / Error check OFF / Repeater OFF / SL-Commands OFF/ Priority TX
Routing	OFF
Tests	OFF
Message Routing	OFF
Serial Interface Type	RS-232 or RS-422 or RS-485

The power cable (+V<sub>b</sub> and GND) must be connected to a power supply with a proper output voltage and with a minimum output current of 1 A (with the SATELLINE-3AS Epic the required output current of the power supply is 5A). The DTR-pin of the serial line connector must also be connected to a positive voltage. Detailed installation instructions can be found in Chapter 10.

If the DTR-pin is not connected, the radio modem will remain in STAND-BY mode and will therefore not send or receive any data.

When creating a test connection, you can either use the *SaTerm* terminal program, (available for free from authorised SATEL dealers or directly from SATEL Customer Support) or HyperTerminal (which is included in most the Windows™ based operating system packages), or almost any other terminal program. Basic settings for the serial port of the host computer, when using a terminal program to communicate with SATEL radio modems, are as follows: "COM1, 19200 bps, 8-bit data, none parity, 1 stop bit". If the serial port designated as COM1 in the host computer is reserved, any other free serial port in the host computer can be used (with the settings listed).

Note: If you want to change the settings of a radio modem using the *Programming Mode* of the radio modem with the help of an external terminal, the data speed of the terminal must be 9600 bps.

Basic connection between a radio modem and the serial port COM1 (RS-232) of a PC is depicted in the schematic below.

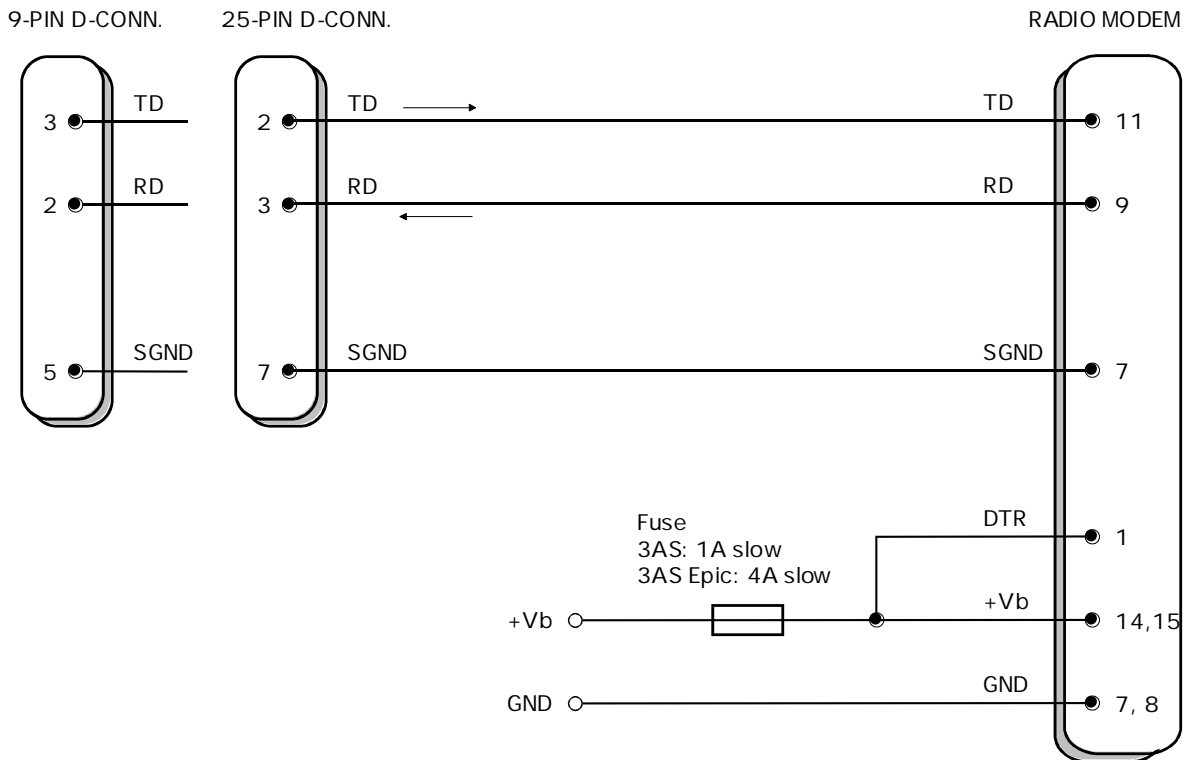

When using the SATELLINE-3AS, the operating voltage can be connected to either pin 14 or 15, and the power supply ground to either pin 7 or 8. Fuse size is 1 A (slow).

When using the SATELLINE-3AS Epic model, the operating voltage must be connected to pins 14 AND 15, and the power supply ground to pins 7 AND 8, due to a larger current consumption. Fuse size is 4A (slow).

### **1.4.1 Prepare installation of SATELLINE-3AS(d) modem into the SATEL-321 casing**

Before installing a SATELLINE-3AS(d) or 3AS(d) 869 modem into the SATEL-321 casing, the battery pack function must be selected as follows:

- o Switch the radio modem into the Programming Mode, see chapter 4.2 Programming Mode.
- o Select main menu selection "5" (Serial Port 2).
- o Enter selection "1" (Port Status).
- o Select "3" (BATT / LCD) for 3ASd or 3ASd 869 modems. Select "4" (BATT / NO LCD) for 3AS or 3AS 869 modems.
- o Save the setting.
- o Switch the radio modem back into Data Transfer Mode.

Please notice that both serial ports must be RS-232, NOT RS-485 / 422 and the SW -version of the 3AS(d) modem must be V 2.16 or later.

Please check the installation advice from the SATEL-321 user guide, Chapter *4.2 Installing a radio modem into the SATEL-321 casing*

## 2 SERIAL INTERFACE

The radio modem is referred to as DCE (Data Communication Equipment) whereas the PC is referred to as DTE (Data Terminal Equipment). SATELLINE-3AS radio modem includes a 15-pin 'D'-type female connector, which contains all the connections required to establish communication between the radio modem, acting as the DCE, and the PC, acting as the DTE.

All EMC-requirements set forth by authorities have been taken into account in the design of the radio modem. The radio modem user is thereby not required to take any special actions regarding EMC-shielding (of the radio modem).

The radio modem contains two separate serial ports, which are designated **Port 1** and **Port 2**. Only one port at a time can be used for communication.

**Port 1** complies always with the RS-232 standard.

**Port 2** can comply either with the RS-232, RS-422 or RS-485 standards. The interface type is set at the factory according to the customer order. The user can change the interface type afterwards in the programming mode.

### NOTE!

WHEN THE MODE-PIN (PIN 12 OF THE D-CONNECTOR) IS CONNECTED TO GROUND, THE RADIO MODEM IS IN THE PROGRAMMING MODE AND **Port 1** (PINS 7, 9, 11) IS THEN IN USE! If you normally use **Port 2** for data transmission, the serial cable must be changed to a suitable type when switching over to the configuration mode.

## 2.1 D15 connector

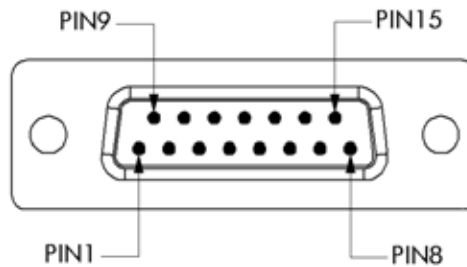

D-15 female connector in the radio modem

Direction **IN** is from DTE (Data Terminal Equipment) to the radio modem.  
Direction **OUT** is from the radio modem to the DTE.

PORT AND TYPE	PIN	DIRECTION	NAME	EXPLANATION
PORT1, both models	6	OUT	CTS	*
	9	OUT	RD1	Receive data (Port1)
	11	IN	TD1	Transmit data (Port1)
	13	IN	RTS	*
PORT2 RS-232 model	2	OUT	CD	
	3	OUT	RD2	Receive data (Port2)
	4	IN	TD2	Transmit data (Port2)
	5	OUT	RSSI	Analog RSSI (Optional HW)
PORT2 RS-422 model	2	OUT	A'	Receive data positive
	3	OUT	B'	Receive data negative
	4	IN	A	Transmit data positive
	5	IN	B	Transmit data negative
PORT2 RS-485 model	2	IN / OUT	A	Data positive **)
	3	IN / OUT	B	Data negative **)
COMMON PINS	1	IN	DTR	ON ( $V_b$ ) / STANDBY (NC)
	10	OUT	DSR	
	12	IN	MODE	DATA (NC) / SETUP (GND)
	7, 8	-	GND	Power Ground
	14, 15	-	$V_b$	Operating Voltage

**NOTE!** Unused pins can be left unconnected.

\*) RTS and CTS handshaking connections remain the same irrespective of the port used (Port 1 or Port 2).

\*\*\*) A and B designators are opposite in Profibus standard.

### Description of pins:

- *RD* = **R**eceive **D**ata. Output of the data received from the radio modem to the DTE.
- *TD* = **T**ransmit **D**ata. Input of the data to be transmitted from the DTE to the radio modem.
- *CTS* = **C**lear **T**o **S**end. See Chapter 5.2.1.
- *CD* = **C**arrier **D**etect. See Chapter 5.2.2.
- *RTS* = **R**quest **T**o **S**end. See Chapter 5.2.3
- *DTR* = **D**ata **T**erminal **R**eady. Terminal in operation. When the DTR-line is connected to a positive voltage (e.g. to the operating voltage,  $V_b$ ), the radio modem is ON, if not, the radio modem is in the *Standby Mode*.
- *DSR* = **D**ata **S**et **R**eady. Indicates that the radio modem is switched ON.
- *RSSI* = **R**eceived **S**ignal **S**trength **I**ndicator. Indicates the strength of the received signal. Can be used to approximately determine the received signal strength. Analog RSSI is a hardware option; it must be specified in the order. See Chapter 3.2.1.
- *MODE* = operational mode. When the MODE-line is connected to ground (GND), the radio modem enters the *Programming Mode* which is used to change the settings of the radio modem (i.e. configuration, set-up). If the MODE-line is not connected, the radio modem will enter the *Data Transfer Mode*, in which data can be transmitted and received. The *Programming Mode* is used only when installing a radio modem and changing the operational parameters of a network. Normally the radio modem is always in the *Data Transfer Mode*. See Chapter 4.2.
- *GND* = both the negative pole of the operating voltage and the signal ground.
- $V_b$  = positive pole of the operating voltage.

## 2.2 RS-232 interface

RS-232 standard defines the method of serial data transfer between a computer and its peripherals. The definition includes both the interface type and signal levels. Most computers and peripherals contain one or more RS-232 type serial ports. The RS-232 standard uses transmission lines, in which each single signal line level is referenced, to a common ground level. RS-232 has been designed to be use in serial transfer of data, in situations where the distance between communicating equipment is less than 15 m. The otherwise useful RS-232 standard is applied in a multitude of slightly differing ways, (e.g. different pin configurations) and for this reason different computers and peripherals are not necessarily directly compatible with each other (see also Chapter 10.2.1 for more information on RS-232 wiring).

## 2.3 RS-422 interface

RS-422 standard defines a serial data transfer method, which is very similar to the RS-232 standard. In RS-422 however, the signal lines are balanced (or differential) transmission lines. A balanced (or differential) transmission line is formed by using two signal wires together to convey each single signal. Because the state of the signal is defined by the mutual voltage difference (hence the name differential), any common mode disturbances induced into the lines will cancel out. The effect of different signals moving in the same cable will also be smaller than in the case of the RS-232. Transmission distance can be considerably longer than when using RS-232 type of connection, and distances of 1 km are possible. (See also Chapter 10.2.2 for more information on RS-422 wiring).

As an example, let's examine the TX-signal: TX-signal will be transmitted using two lines (A and B). A logical "1" corresponds to a situation, where the voltage on line A is greater than the voltage on line B. Correspondingly a logical "0" corresponds to a situation, where the voltage on line A is smaller than the voltage on line B.

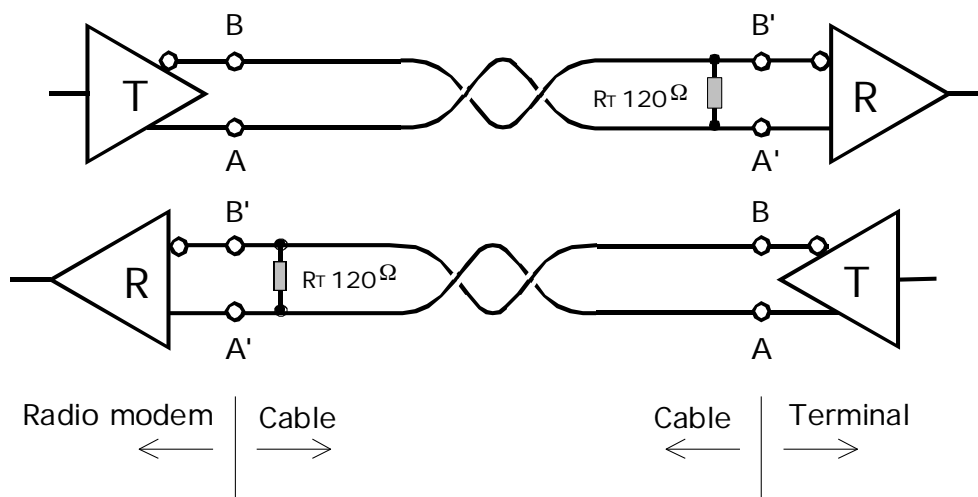

## 2.4 RS-485 interface

RS-485 is an extension of the RS-422 standard and enables the connection of more than two devices on to the same bus. Communication is half-duplex, so there is only one cable pair, compared to two when using the RS-422. The RS-485 standard defines the electrical characteristics of the connections in such a way as to prevent possible data contention states as well as cable shorts etc. from harming the devices themselves. (See also Chapter 10.2.3 for more information on RS-485 wiring).

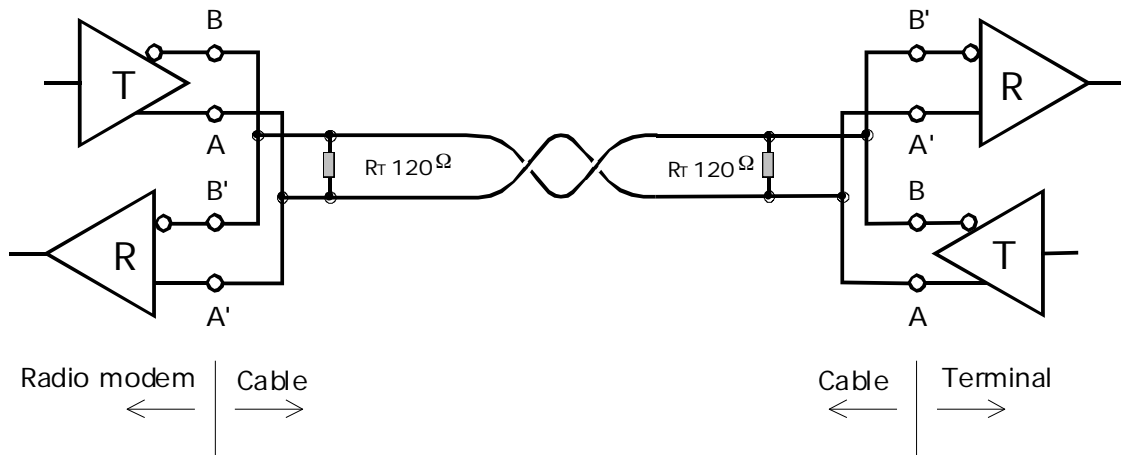

## 2.5 Termination of RS-422/485 lines

Each differential pair of wires is a transmission line. A transmission line must be terminated properly to prevent, or at least minimise, harmful reflections formed between the transmitting and receiving end of the transmission line. A common method of terminating a RS-485 type of transmission line is to connect a so-called termination resistor, between the wires and at both ends of the transmission line. Even when there are more than two devices on the same transmission line, the termination resistors are needed only at the ends of the transmission line. The termination resistor must be selected so that its resistance matches the characteristic impedance of the transmission line as close as possible (typical values range from 100 to 120 ohm). When using a RS-422 type of connection the termination resistor is connected only at each of the receiving ends. Termination resistors are particularly important when using long transmission lines and/or high data transfer speeds.

## 3 RF INTERFACE

The SATELLINE-3AS(d) has a single TNC-type connector with impedance of 50 Ohm. The SATELLINE-3AS Epic model has two antenna connectors, the one on the left being both for transmitting and receiving and the one on the right being for receiving only.

Note for SATELLINE-3AS Epic model: the diversity reception i.e. the secondary receiver of the SATELLINE-3AS Epic can be switched off (in a single antenna application) by changing the setting *Diversity Mode* OFF in the programming menu. See Chapter 9.1.2.

It is recommended to terminate the unused antenna port by placing a suitable cap on the TNC connector.

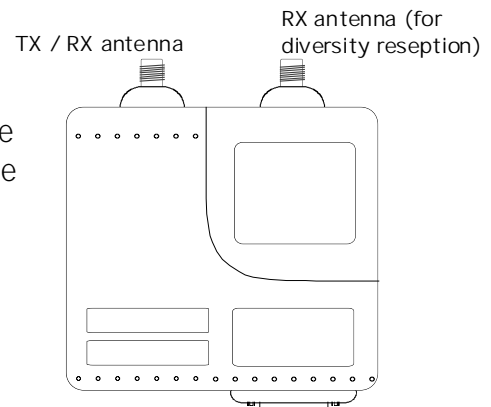

When ordering the radio modem, the frequency band to which the radio modem will be tuned to at the factory must be defined. The user can change the frequency of the radio modem afterwards by  $\pm 2$  MHz from the centre frequency (basic tuning range), or inside 2 X 2 MHz frequency bands when using the special Dual Band version. Of course, all local regulations set forth by the authorities must be taken into consideration. The 869 MHz model contains ten 25 kHz channels.

The data speed of the radio interface depends on the chosen radio channel spacing. A channel spacing of 25 kHz enables a data speed of 19200 bps and a channel spacing of 12.5 / 20 kHz enables, correspondingly, a data speed of 9600 bps. The data speed of the radio interface is always fixed (19200 bps or 9600 bps) irrespective of the data speed of the serial interface. If the data speeds of the radio interface and the serial interface differ from each other, the radio modem will buffer the data in transfer temporarily, so no data loss will occur. The radio channel spacing is set at the factory and cannot be changed afterwards.

### 3.1 Transmitter

The output power of the transmitter is adjustable. The greatest allowable power depends on limits set by local authorities, which should not be exceeded under any circumstances. The output power of the transmitter should be set to the smallest possible level, which still ensures error free connections under variable conditions. Large output power levels using short connection distances can, in the worst case, cause disturbances to the overall operation of the system.

OUTPUT POWER	dBm	3AS	3AS 869 MHz	3AS Epic
10 mW	+10	○	○	
20 mW	+13	○	○	
50 mW	+17	○	○	
100 mW	+20	○	○	
200 mW	+23	○	○	
500 mW	+27	○	○	
1 W	+30	○		○
2 W	+33			○
5 W	+37			○
10 W	+40			○

Possible output power settings of the SATELLINE-3AS –line of radio modems.

**NOTE!**

Setting the radio data modem output power level to that which exceeds the regulations set forth by local authorities is strictly forbidden. The setting and/or using of non-approved power levels may lead to prosecution. SATEL and its distributors are not responsible for any illegal use of its radio equipment, and are not responsible in any way of any claims or penalties arising from the operation of its radio equipment in ways contradictory to local regulations and/or requirements and/or laws.

SATELLINE-3AS Epic radio modem is shipped with two different cooling elements. If the transmitter of the radio modem is to be ON full power over 20 % of the operating time, additional cooling is required.

### 3.2 Receiver

The sensitivity of the receiver depends on the channel spacing of the radio modem (=data speed of the radio interface) and on the mode of the FEC (error correction) according to the table below:

	FEC OFF	FEC ON
25 kHz	-110 dBm	-113 dBm
20 kHz	-112 dBm	-115 dBm
12.5 kHz	-112 dBm	-115 dBm

Effect of settings on the receiver sensitivity

The Signal Threshold Level setting of the receiver determines a level, above which the search for the actual data transfer signal is active. It is recommended that values given in the table are used. If the Signal Threshold Level setting is set too low (the CD-LED is ON constantly), it is

possible that the receiver is trying to synchronise itself with noise, in which case, the actual data transmission might remain unnoticed. Alternatively, weak data transmissions will be rejected, even though they would be otherwise acceptable.

SATELLINE-3AS Epic –radio modem contains two separate receivers, and a selection is made between the received signals in order that the stronger/better signal is used. By using this method, the signal fading caused by multipath propagation will be smaller than if just one antenna and receiver are used. The recommended minimum distance between receiving antennas is  $\frac{3}{4}$  wavelengths, which at a frequency of 450 MHz corresponds to a distance of 50 cm.

### 3.2.1 RSSI-signal

RSSI-signal (**R**eceived **S**ignal **S**trength **I**ndicator) (pin 5 of the D-type connector) gives an indication of the strength of the received radio signal. This signal can be used to determine the approximate signal level. The curve on the following diagram describes a typical relationship between the received signal strength and the voltage at pin 5.

RSSI value of the last received message can also be requested locally by using a SL command (SL@R?, see chapter 9.3.3). The RSSI value is available 7s after the reception of the message. After that the value is returned to zero. SATELLINE-3AS Epic responds by the stronger RSSI value of the two receivers.

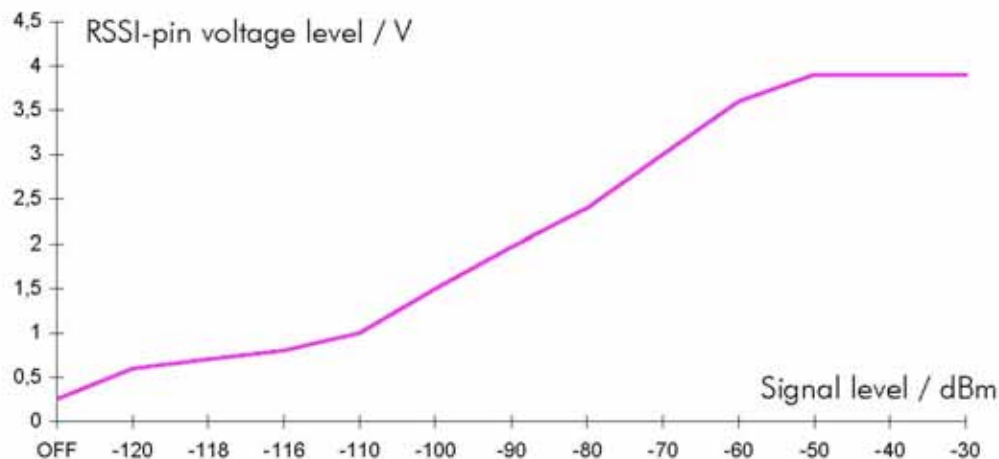

#### NOTE!

SATELLINE-3AS(d) and SATELLINE-3AS(d) Epic radio modems marked with the text "E2" on the serial number label (all SATELLINE-3AS(d) radio modems delivered since mid-June 2004) are NOT equipped with RSSI pin by default, because it requires a special hardware assembly. If RSSI is required it must be clearly stated in the order (with Epic modem please mention also the antenna port, RX/TX or RX only, from where the RSSI is required). Note also that Serial Port 2 (RS-232/485/422) and RSSI pin options are alternative.

### 3.3 Priority RX/TX

SATELLINE-3AS offers a *Priority* setting, which selects the priority between reception and transmission. The setting can be changed in *Programming Mode*. By default, transmission has higher priority than reception i.e. the default value is Priority TX.

*Priority TX* means that a terminal device attached to a radio modem decides the timing of the transmission. The transmitter is immediately switched on when the terminal device starts to output data. Should reception be in progress, the radio modem will stop it and change to a transmit state. There is no need to use any handshaking for the control of timing.

*Priority RX* means, that a radio modem tries to receive all data currently in the air. If a terminal outputs data to be transmitted (or an SL command) it will be buffered. The radio modem will wait until the reception has stopped before transmitting the buffered data. This will result in timing slacks to the system, but decreases the number of collisions on the air; this is particularly useful in systems based on multiple random accesses.

To toggle the *Priority* setting in the programming menu, select:

1) `Priority   RX / TX`

If the Repeater Function has been set on (see chapter 6.1), priority setting is automatically switched to RX mode.

### 3.4 Error correction

Another new feature of the SATELLINE-3AS is the addition of an error correction mode called the FEC-method (**F**orward **E**rro**R** **C**orrection). FEC-function is switched ON (or OFF) by using the *Programming Mode*. When activated, the FEC-function will cause the SATELLINE-3AS to automatically add additional error correction information, which increases the amount of transmitted data by 30 %. It is used by the receiving radio modem to correct erroneous bits - as long as the ratio of correct and erroneous bits is reasonable.

Error correction improves the reliability of data transfer via the radio interface especially in unfavourable conditions. FEC-function should be used when link distances are long and/or if there are many disturbances in the radio channels used. The use of the FEC-function will, however decrease the data transfer throughput of data by about 30 %. For a listing of exact delays introduced by using FEC-function, see Chapters 15.1 and 15.2.

To switch the FEC-function ON in the *Programming Mode*, select:

1) `Error correction   ON`

#### NOTE!

All radio modems, which are to communicate with each other, must have the same setting for FEC (ON or OFF). If the transmitting radio modem and the receiving radio modem has different settings, data will not be received correctly.

### 3.5 Error checking

When the error checking is switched on, the radio modem will add a checksum to the transmitted data. When the data is received, the checksums are verified before data is forwarded to the serial port. There are two different options for error checking that can be accessed in the Additional setup menu in the Programming Mode:

- 2) Error check
- 6) Full CRC16 check

*Error check* checks data partially while data is received.

*Full CRC16 check* function adds two checksum characters at the end of the user data message. At the reception end the receiver receives first the whole package and if the checksum matches the data message is forwarded to the serial port. If *Full CRC16 check* is selected it must be set ON for all radio modems in the same network. Otherwise the checksum characters appear at the end of user message on the serial port.

### 3.6 Dual Band version

SATELLINE-3AS(d) radio modem is also available as a special "Dual Band" version. The radio transceiver of the Dual Band version offers two times two MHz frequency bands, and radio modem can be reprogrammed to operate at any channel within those two bands. Frequency bands are tuned at the factory and the maximum separation between the highest and the lowest frequency is 15 MHz (see the diagram on next page).

The centre frequency ( $f_c$ ) is set to the middle of the two frequency bands at the factory. When using the SL-commands please note that SL&F=nnn.nnnn is the only command for frequency change that works in all cases. (SL&+/-=nn command can be used only when the required value for nn does not exceed 99.)

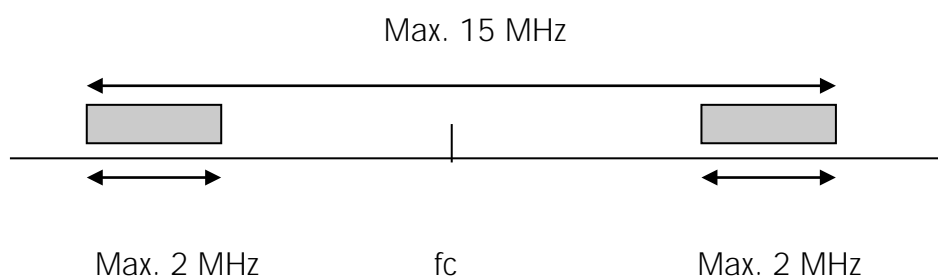

#### **NOTE!**

SATELLINE-3AS(d) Dual Band is a special hardware version, and the frequency adjustment is made case by case. Before starting the system design procedure please contact the manufacturer for checking the technical details.

### 3.7 Dual Channel function

By setting the "Dual Channel" function on, the SATELLINE-3AS radio modem can transmit and receive data on separate channels. The radio modem is initially at the receive channel. Data flow on the TD line starts automatically the frequency shifts to the transmit channel. The delay caused by the frequency shift before the actual data transmission sequence is 40 ms, and the same is needed for the return to the receive channel after transmission.

The extra delay from a modem to another is shown below:

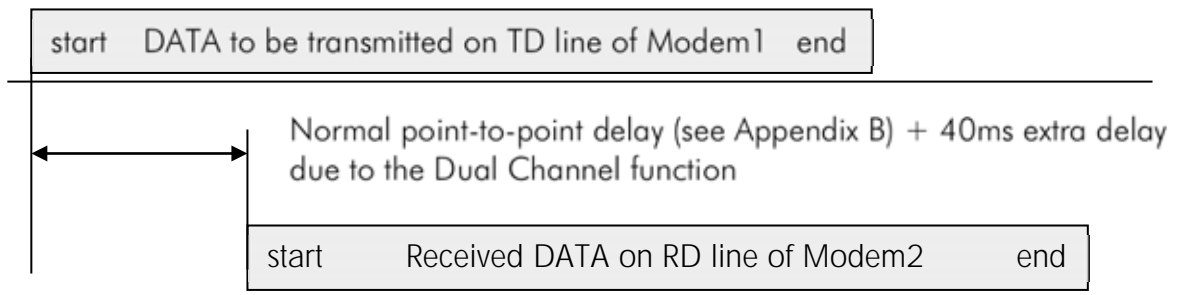

The table below specifies the use of the frequency bands vs. Dual Channel settings.

	Band 1 (Active channel)	Band 2
Dual Channel selected	Transmit Channel	Receive Channel
Reverse Dual Channel selected	Receive Channel	Transmit Channel

The separation between transmit and receive frequencies is equal to the separation between the lower limits of the specified frequency bands (Lower limit band 1 and Lower limit band 2). Frequency bands are set in such a way that the other band covers the receive frequencies and the other includes the transmit frequencies. See below (Dual channel mode is DUAL in this example).

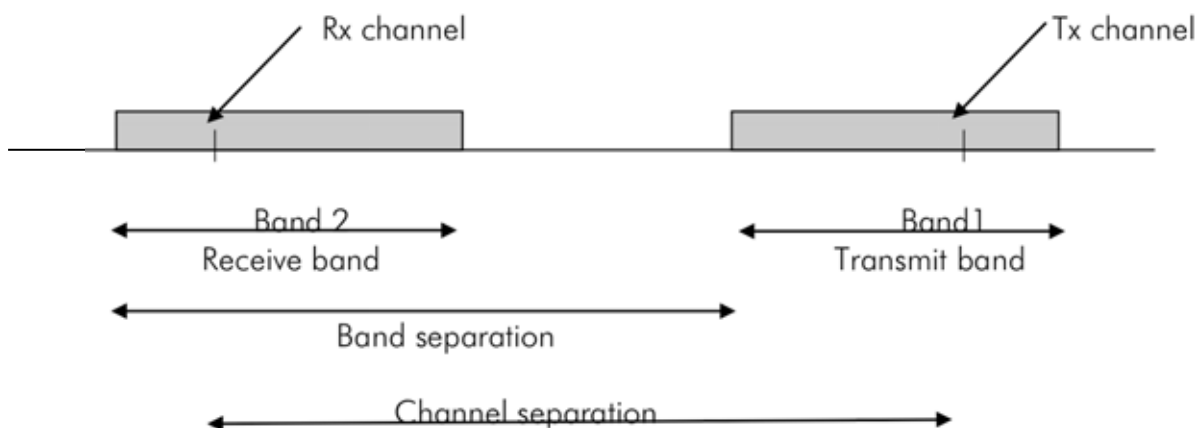

The frequency bands for Dual Channel function can be set within the standard operational band of 4 MHz, or the special Dual Band hardware version may be used for the larger frequency separation (max. 15 MHz). With the help of SL commands the modem can be set to Single, Dual or Reverse Dual Channel mode (Single Channel = normal one channel mode). The dual channel settings can be changed also by the SL command, see chapter 9.3.1.

### 3.8 Free Channel Scan (FCS) function

Free Channel Scan (FCS) is designed for one-way transmission between one transmitter and one or more receivers when there are at least two different radio frequencies available. The transmitter monitors the noise level of the channels between the transmissions and finds the best transmission channel. The receivers scan and follow the frequency of that particular transmitter consequently.

The feature is beneficial e.g. for the applications in land surveying or when license free channels are used and there could be other transmitters using the same channels.

The FCS function is supported starting from the software version 3.07.

To make the use easier SATEL provides the FCS terminal software for your PC. Using the program it is easy to configure the radio modems to use the FCS function. There is also a scanning tool for measuring the power level of the selected radio channels. A more detailed description of FCS function and FCS terminal software is available from the manufacturer or from the nearest distributor.

A screen snapshot of the FCS terminal software below:

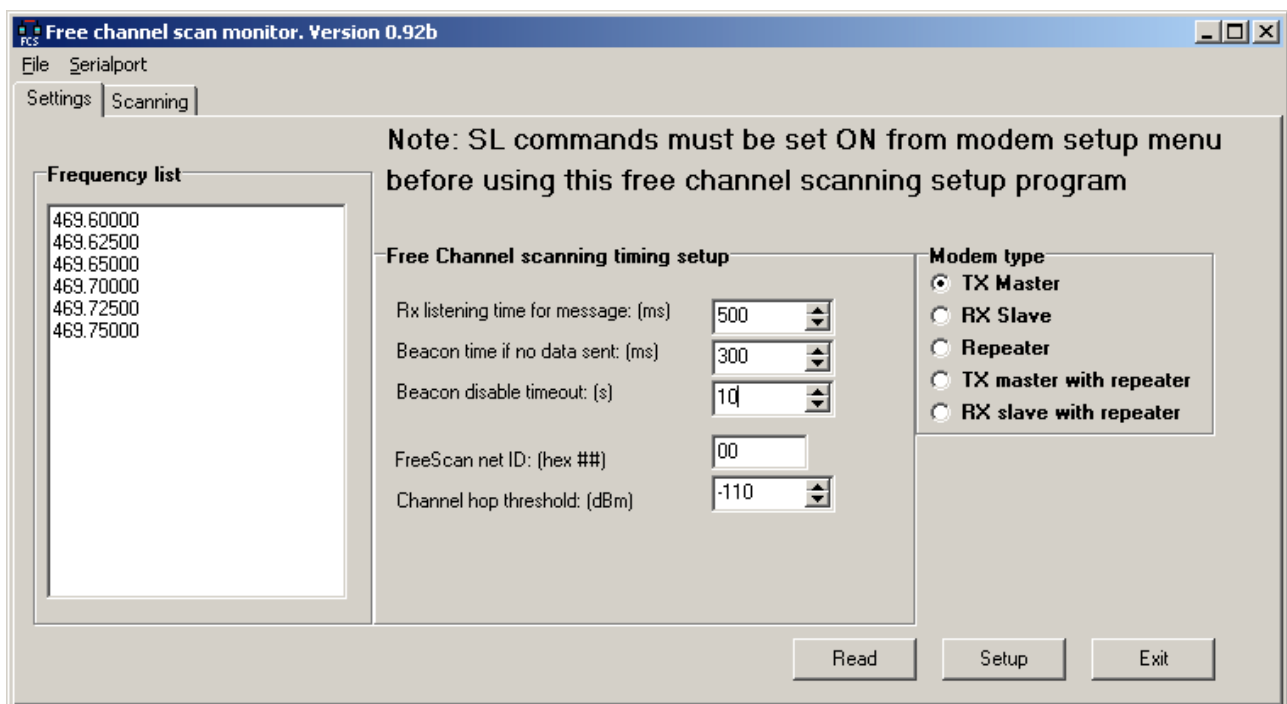

### **3.9 User data whitening**

In some cases, if the user data includes a large number of constant characters, additional bit errors may appear. The use of error correction (FEC) is recommended in such cases. If that is not possible, the Data whitening feature can be used to improve the reliability of data transfer. The feature is set on/off in the programming mode.

**NOTE!**

All radio modems, which are to communicate with each other, must have the same setting for Data whitening (ON or OFF). If the transmitting radio modem and the receiving radio modem has different settings, data will not be received correctly.

### **3.10 Pacific Crest and TRIMTALK compatibility**

#### **3.10.1 General**

SATELLINE-3AS(d) and Epic radio modems support additional to the original SATEL 3AS data transfer also:

- o Pacific Crest compatible data transfer over the air, if the opponent Pacific Crest modems operate in the transparent mode/FEC ON/Scrambling ON that is the most common setup among RTK applications. The other modes are currently not supported.
- o TRIMTALK® 450s compatible data transfer over the air.

SATELLINE-3AS(d) and Epic radio modems provide the following radio compatibility settings:

- o Option 1 for Pacific Crest 4-FSK modulation, Transparent mode/FEC ON/Scrambling ON.
- o Option 2 for Pacific Crest GMSK modulation, Transparent mode/FEC ON/Scrambling ON.
- o Option 3 for TRIMTALK GMSK modulation, Transparent mode

So far, only the transparent mode is implemented, since it is the most commonly used and recommended by the user manuals. The ARQ based protocols with ACK/NACK schemes are not preferred in RTK applications that apply one-way communication.

The implementation of Options 1, 2, 3 is based on the reference measurements and the available public data of the following radio modems manufactured by Pacific Crest Corporation: RFM96W, PDL HPB, PDL LPB. TRIMTALK is a trademark of Trimble Navigation Ltd.

#### **3.10.2 Configuration in Programming menu**

The correct radio compatibility mode can be changed in the Programming mode submenu *Radio settings ->Radio compatibility Mode*:

Radio compatibility  
-----

- 1) Satel 3AS
- 2) Option 1 (PCC 4-FSK)
- 3) Option 2 (PCC GMSK)
- 4) Option 3 (TRIMTALK GMSK)

### 3.10.3 Configuration by using SL commands

"SL@S=" command selects the compatibility mode:

- o "SL@S=0" sets SATEL 3AS (default).
- o "SL@S=1" sets Option1 (PCC-4FSK)
- o "SL@S=2" sets Option 2 (PCC-GMSK)
- o "SL@S=3" sets Option 3 (TRIMTALK GMSK)

The modem responds with "OK" message if the requested mode is supported or "ERROR" if the mode is not allowed.

"SL@S? enquires the active mode. The modem responds with a number:

- o "0" if the mode is SATEL 3AS
- o "1" if the mode is Option 1
- o "2" if the mode is Option 2
- o "3" if the mode is Option 3

### 3.10.4 Settings

In order to use the Pacific Crest/TRIMTALK modes implemented in SATELLINE modems:

PACIFIC CREST modems must have:

- o Protocol Mode =
  - o Transparent w/EOT Timeout (when using Pacific Crest modulations)
  - o TrimTalk 450s (when using TRIMTALK GMSK modulation)
- o Modulation Type depends on the system
  - o GMSK (default, always selected when using TRIMTALK 450s mode)
  - o 4-Level-FSK
- o FEC = ON
- o Scrambling = ON
- o Data Security Code set to = 0 (=not used)
- o Local Address= 0...254 (0 by default)  
Pacific Crest modem receives messages from SATELLINE modems that have their TX1 address matching the Local Address.
- o Remote address=0...255 (255 by default, that is the broadcast address to be received by all). SATELLINE modems receive the message from a Pacific Crest radio, provided their RX1 address matches the Remote Address of a Pacific Crest transmitter (or if the message has the broadcast address 255).

SATELLINE modems must have the following key settings:

- o FEC OFF (because the FEC here means SATEL 3AS FEC, not Pacific Crest/TRIMTALK FEC )
- o Error check OFF

- o Full CRC16 check OFF
- o Radio Compatibility Option 1 in case of Pacific Crest 4-FSK
- o Radio Compatibility Option 2 in case of Pacific Crest GMSK
- o Radio Compatibility Option 3 in case of TRIMTALK GMSK
- o Addressing:
  - o When TX address is selected ON, then TX1 address is used like PDL Remote address that is the destination address for the transmitted messages.  
Default value is 0x00FF (=255) (note the hexadecimal format of the setting)
  - o When RX Address is selected ON, then RX1 address is used like PDL Local address  
Default value is 0x0000 (=0) (note the hexadecimal format of the setting)

Note: Addresses are NOT applicable in TRIMTALK 450s mode so SATELLINE modems must have their RX/TX addresses OFF with Option3.

The configuration tools and settings are different between SATELLINE and Pacific Crest modems:

- o Pacific Crest modems are configured via the serial port using PDLCONF Windows™ program that sends binary control messages to the serial port of the modem.
- o SATELLINE-3AS and SATELLINE-M3 radio modems are configured via the serial port using any ordinary terminal program or SATEL Configuration Manager PC-program.

The table below shows the analogy of settings between Pacific Crest and SATELLINE radio modems (status in software version 3.35).

<b>Pacific Crest setting</b>	<b>Corresponding SATELLINE-3AS setting</b>
Identification: Owner	(not implemented)
Identification: Channel Bandwidth	Channel spacing
Identification: RF Power	TX power
Radio Link: Channel Selection Type (Manual)	Radio frequency
Radio Link: Current Channel	Radio frequency
Radio Link: Link Rate	The fixed link rates are: Option 2 & 3: 9600bps@25kHz / 4800bps@12.5kHz Option 1: 19200bps@12.5kHz / 9600bps@12.5kHz
Radio Link:Modulation Mode	Compatibility->Option 1 (=PCC-4FSK) Compatibility->Option 2 (=PCC-GMSK) Compatibility->Option 3 (=TRIMTALK GMSK)
Radio Link:Scrambling	ON by default
Radio Link:Transmit Retries	(not implemented)
Radio Link:TX ACK Timeout	(not implemented)
Radio Link:Cdma Monitoring	Priority (RX=ON, TX=OFF) Default: RX
Radio Link: AutoBase/AutoRover	(not implemented)
Radio Link:Digisquelch	Signal threshold
Radio Link:Forward Error Correction	ON by default using Option 1, 2, 3 (Note: SATELLINE-3AS FEC must be OFF!)
Radio Link:Local Address (0 by default)	Primary RX address (RX1) (OFF by default)
Radio Link:Remote Address (255 by default)	Primary TX address (TX1) (OFF by default)
Serial Interface:Protocol Mode	Radio compatibility: Options 1 and 2 = Transparent w/EOT Timeout

	Option 3 = TRIMTALK 450s
Serial Interface: BREAK to Command	(not implemented)
Serial Interface: Modem Enable: Yes	(not applicable)
Serial Interface: Soft Break Enable	(not implemented)
Serial Interface: EOT value (in 0.01s units)	Pause length (in serial port byte intervals)
Serial Interface: Digipeater Delay (in 0.01s units)	(not implemented)
Serial Interface: Local Node Repeater	(not implemented)
Frequency Table	Radio frequency
Data Security Code (must be 0=not used)	(not implemented)
Potential conflicts: - Pacific Crest Local/Remote addresses are supported in the firmware versions starting from v3.39 - Repeater function is supported only in the firmware versions starting from v3.39 - Error check and Full CRC16 check must be OFF in SATELLINE modem - FCS (Free Channel Scanning) feature is not supported by Pacific Crest radios - Message Routing is not supported by Pacific Crest radios - SATELLINE RX/TX addressing does not use ARQ scheme like Pacific Crest radios.	

### 3.10.5 Repeater function

The implemented Pacific Crest/TRIMTALK modes support also the repeater function. The repeater function is configured either by using the SL commands:

"SL@M=R" (Repeater ON)

"SL@M=O" (Repeater OFF)

or by selecting Repeater OFF/ON in the Additional setup-> Repeater programming menu.

Note 1. The repeater modem passes TRIMTALK messages also to its serial port unlike for example Pacific Crest PDL modems.

Note 2. SATELLINE-3AS(d) Epic-modems do NOT support the DIVERSITY reception in TRIMTALK mode, consequently the Diversity setting must be OFF.

Note 3. If error correction is ON (FEC ON) and TRIMTALK mode is activated by using "SL@S=3" command, the firmware automatically switches SATEL FEC OFF temporarily, and turns it back at the mode return.

### 3.10.6 Support for Local / Remote addresses

If the modem has TX address ON then primary TX address is handled in the same way as Remote address in Pacific Crest PDL modems. The default value is 0x00FF (255 in decimal format) i.e. the broadcast address.

If the modem has RX address ON then primary RX address is handled in the same way as PDL Local address in Pacific Crest PDL modems. The default value is 0x0000 (0 in decimal format).

SATELLINE modem needs to have TX Delay 50ms or more in order to avoid messages from colliding in case it is to be placed in a Pacific Crest system that uses addressing and acknowledging scheme.

In case only broadcast messages are used (like in RTK applications) there is usually no need for TX Delay, except if the transfer delays identical to Pacific Crest modems are preferred – in such cases an appropriate value of TX Delay is 34 ms.

Note 1. SATELLINE-modems do not support Pacific Crest retransmit/acknowledge scheme. However, that has no effect in RTK applications because they utilize only broadcast messages.

### 3.10.7 Latency

In the PCC Transparent protocol mode (Option 1 and Option 2) the whole message is first read from the serial port and after that it will be framed and transmitted over the radio. The end of the message is detected when there is a pause in data coming from the serial port.

The symbol rates for the Pacific Crest 4FSK (Option1) are:

- o 19200 bps on 25 kHz channel
- o 9600 bps on 12.5 kHz channel

The symbol rates for the Pacific Crest GMSK (Option2) are:

- o 9600 bps on 25 kHz channel
- o 4800 bps on 12.5 kHz channel

The actual raw data rate is appr. 2/3 of the symbol rate.

#### 3.10.7.1 Transmission delays using Option 1 (Pacific Crest 4FSK) on 25 kHz channel

The table below presents the typical latency vs. the size of the message. The delays are measured from the end of transmitted data to the end of received data on the serial interface.

Number of bytes sent				
Bps	1	10	100	500
1200	77 ms	159 ms	971 ms	4590 ms
4800	48 ms	68 ms	317 ms	1438 ms
9600	43 ms	52 ms	209 ms	912 ms
19200	40 ms	45 ms	154 ms	650 ms
38400	39 ms	41 ms	127 ms	519 ms

3.10.7.2 Transmission delays using Option 2 (Pacific Crest GMSK) on 25 kHz channel

The table below presents the typical latency vs. the size of the message. The delays are measured from the end of transmitted data to the end of received data on the serial interface.

Number of bytes sent

Bps	1	10	100	500
1200	86 ms	168 ms	1042 ms	4949 ms
4800	57 ms	77 ms	390 ms	1796 ms
9600	52 ms	62 ms	281 ms	1272 ms
19200	50 ms	55 ms	226 ms	1009 ms
38400	48 ms	51 ms	198 ms	878 ms

## 4 USER INTERFACE

### 4.1 LED-indicators

There are five (5) LED indicators on the front panel of the radio modem, and they give an indication of the status of the serial port and the radio interface:

LED	Indication	OFF	Red	Orange	Green
RTS	RTS-line status	Inactive	Active		
CTS	CTS-line status	Inactive	Active		
TD	TD-line status	No data	Data		Test Tx active
RD	RD-line status	No data	Data		
CD	Radio status	No signal	Transmission	Noise	Reception

#### Description of the LED-indicators:

1. *RTS* indicates the status of D-connector pin 13.
2. *CTS* indicates the status of D-connector pin 6.
3. *TD* indicates that the radio modem is receiving data via serial port.
4. *RD* indicates that the radio modem is sending data via serial port.
5. *CD* indicates the status of the radio interface. The status of the CD-signal on the serial interface may differ from the status of the LED-indicator.

### 4.2 Programming Mode

The settings of SATELLINE-3AS are fully configurable in *Programming Mode* by using a suitable terminal program. The most recommendable set-up is NARS-1F interface adapter, CRS-9 cable, a power supply and the *SaTerm* terminal program. NARS-1F contains a switch to enable easy shifting into the *Programming Mode*. Other suitable terminal programs and cables may also be used.

The radio modem will shift into the *Programming Mode* by connecting the D-connector pin 12 to ground (GND). When using the NARS-1F, this can be accomplished by moving the slide switch downwards.

In the *Programming Mode*, the radio modem will use serial port **PORT1**, with settings 9600 bps, N, 8,1 (data transfer speed 9600 bps, no parity, 8 data bits and 1 stop bit). For more detailed instructions for changing each setting, see Chapter 9.1 and 9.2.

### 4.2.1 Changing the settings

- Connect cables (RS-232 cable to PC COM-port, power supply cable to power supply).
- Switch on the PC and start *SaTerm* program (or other terminal program).
- Open a terminal window and then choose "Pr" (in case you are using some other terminal program, set the serial port parameters of the program as follows: 9600 bits/s, 8 data bits, no parity, 1 stop bit, which is always the default in *Programming Mode*).
- Connect PROG-pin to ground (if using the NARS-1F adapter, slide the switch downwards), the radio modem shifts now into the *Programming Mode*. The screen should look similar to the one shown in the picture below.
- Make desired changes to the settings.
- Save changes by pressing "E" in the main menu. If you don't want to save changes, press "Q".
- Disconnect PROG-pin from ground (if using the NARS-1F adapter, slide the switch upwards), the radio modem should now return to the *Data Transfer Mode*.

```
-----  
***** SATELLINE-3AS *****  
SW version 3.XX / HW: uCE3/TC4x  
-----  
Current settings  
-----  
1) Radio frequency   XXX.XXXXX MHz ( CF XXX.XXXXX MHz, spacing 25kHz )  
2) Radio settings   TX power 1000 mW / Signal threshold -112 dBm / FCS OFF /  
TX start delay 0ms / Diversity RX OFF / EPIC PWRsave OFF /  
Compatibility Satel 3AS / Call sign OFF  
3) Addressing       RX address OFF / TX address OFF /  
RX address to RS port OFF / TX address autoswitch OFF  
4) Serial port 1    ON / 9600 bit/s / 8 bit data / None parity /  
1 stop bit  
5) Serial port 2    OFF / 9600 bit/s / 8 bit data / None parity /  
1 stop bit ( RS-232 )  
6) Handshaking      CTS Clear to send / CD RSSI-threshold /  
RTS Ignored / Pause length 3 bytes  
7) Additional setup Error correction OFF / Error check OFF / Repeater OFF /  
SL-commands OFF / Priority TX / Full CRC16 check OFF /  
User Data Whitening OFF  
8) Routing          OFF  
9) Tests            OFF  
A) Restore factory settings  
E) EXIT and save settings  
Q) QUIT without saving  
Enter selection >
```

### 4.2.2 Restoring factory settings

Selecting menu selection "A" may restore factory settings.

```
Enter selection >A
Restore factory settings
-----
Do you want to restore factory settings? (Y/N)>
```

Factory settings are restored by selecting "Y" (YES). By pressing any other button current settings will remain active. The modem will ask this question twice to make ensure that this is a valid command.

### 4.3 Display and push buttons (SATELLINE-3ASd and -3ASd Epic)

SATELLINE-3ASd includes a LCD-display (Liquid Crystal Display) with a backlight. In the *Data Transfer Mode* the display will show the operating settings of the radio modem, radio field strength and the supply voltage. By using the push buttons and the LCD-display, it is possible to change most of the settings of the radio modem, without the need for an external terminal. The display backlight illuminates automatically as soon as a button is pressed

The radio modem will shift into the *Programming Mode* by pressing the SET-UP-push button ( ■ ) The LCD-display will then briefly display the model of the radio modem and the version number of the installed software, after which the main menu appears which is a listing of the changeable parameters.

With the help of the main menu, sub-menus can be selected which in turn can be used to change the settings. You can always return to the previous higher level of the menu structure by pressing the CANCEL (or BACK) push button. Pressing the ▲ or ▼ button changes settings. Selections are confirmed by pressing the SELECT or SET button. In case of numerical values the digit to be changed is selected by pressing the NEXT button (see following page).

SATELLINE-3ASd / 3ASd Epic LCD-DISPLAY AFTER POWER-UP

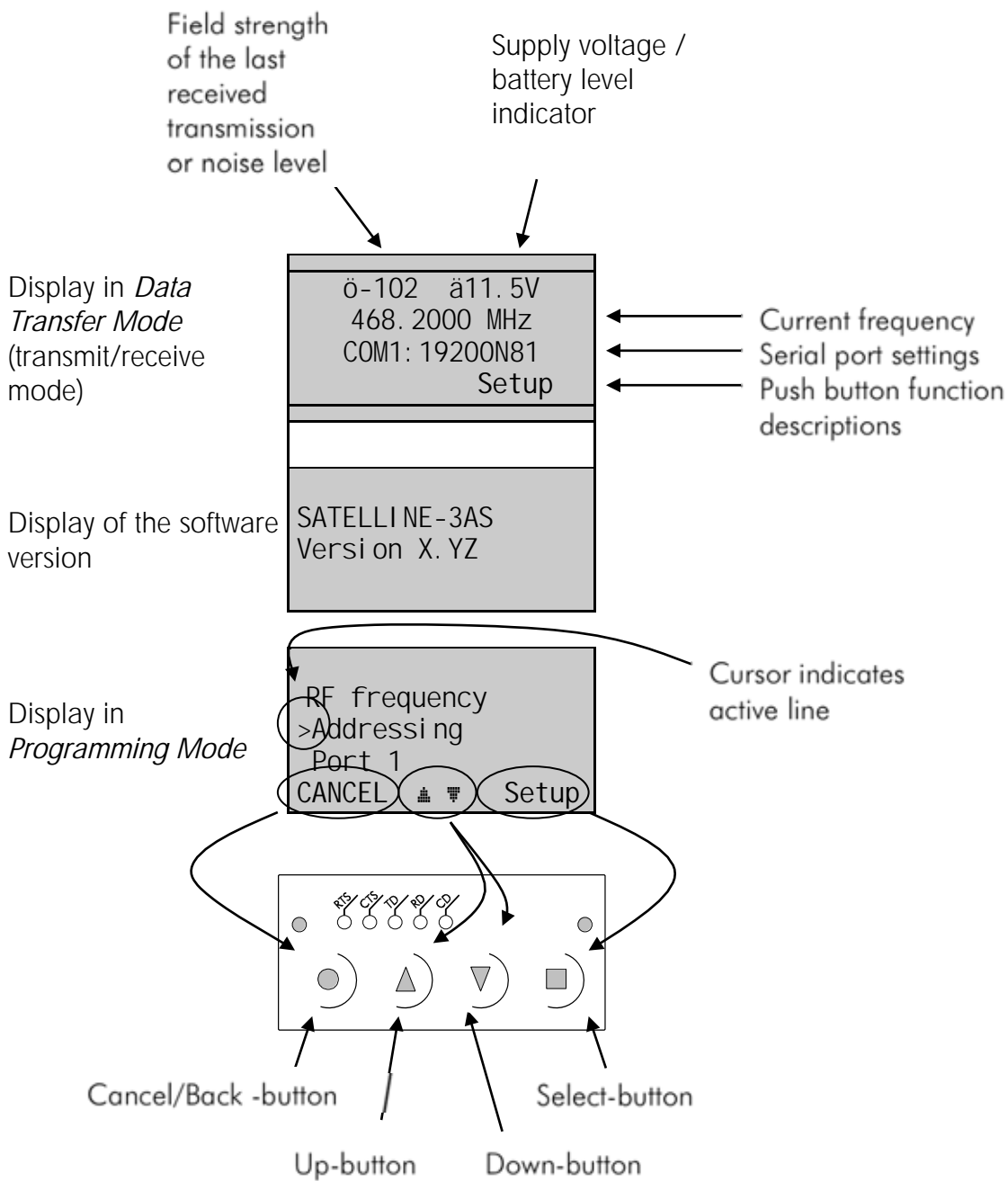

## 5 TRANSPARENT DATA TRANSMISSION

### 5.1 Serial interface, data format

The SATELLINE-3AS radio modem serial interface uses an asynchronous data format. No external synchronising signal is needed, since necessary timing information is acquired from the start and stop bits transmitted before and after each data field bits (byte).

The data transfer speed of the serial interfaces can be set to 300, 600, 1200, 2400, 4800, 9600, 19200 or 38400 bps (bits per second). The length of the data field must be 7, 8 or 9 bits. When using a data field length of 7 or 8 bits, a parity bit may also be used.

One character to be transmitted will thus contain a start bit; the data bits (which define the specific character in question); an optional parity bit and one or two stop bits. The overall length of one character is therefore 10, 11 or 12 bits. This should be taken into account when calculating the data throughput capability of a system. In other words, the number of start, stop and parity bits must be considered. A useful rule of thumb is that at a data transfer speed of 9600 bps, the transmission of one character will require roughly one millisecond (1 ms).

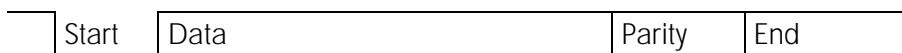

Asynchronous character data format

**Example:** With an 8-bit data character length and taking, for example, a decimal value of "204", (which corresponds to a binary value of "11001100") and with a start bit value of "0", parity bit set to either "NO" (NONE), "0" or "1" and with a stop bit value of "1", the possible combinations are listed in the table below:

DATA FORMAT	CHARACTER	CHARACTER LENGTH
8 bit, no parity, 1 stop bit	0110011001	10 bit
8 bit, even parity, 1 stop bit	01100110001	11 bit
8 bit, odd parity, 1 stop bit	01100110011	11 bit
8 bit, no parity, 2 stop bits	01100110011	11 bit
8 bit, even parity, 2 stop bits	011001100011	12 bit
8 bit, odd parity, 2 stop bits	011001100111	12 bit

If the settings of data speed, character length, parity or the number of stop bits differ between the radio modem and the terminal, errors will be introduced into the transferred data. The serial port settings of each individual radio modem in a system can all be different apart from the data length setting (7, 8 or 9 bits), which must always be the same in each individual radio data modem. In other words, the serial port used, the data transfer speed, parity and number of stop bits; can be different in different parts of a same system. This is especially useful where one part of the system uses an RS-485 serial port and another part uses the RS-232 serial port. In other words, radio modems may also be utilised as serial port adapters in addition to the more common role of wireless data transfer.

The serial port settings can be changed in the *Programming Mode*.

## 5.2 Handshake lines

When using the RS-232 serial interface, handshake signals can be used to control data transfer. Handshake signals are used, for example, by the radio modem to inform the terminal that the radio channel is busy, and that it cannot initiate transmission. The terminal can also control the radio modem via RTS-line.

Line	Direction
CTS	To terminal
RTS	To modem
CD	To terminal

A common way of using handshaking signals is to monitor the CTS-line and ignore the others. Usually the terminal is fast enough to handle the data received by the radio modem, so the use of RTS-line is not necessary.

Handshaking is not needed if the system protocol is designed to prevent collisions (data contention) by the use of polling, or if there is little traffic and also if there is no harm from occasional data contention situations (several radio modems try to transmit at the same time).

### 5.2.1 CTS-line

The options for CTS-line are:

#### 1) **Clear To Send**

CTS is active when the radio modem is ready to accept data for new transmission. CTS will shift into inactive state during data reception and transmission.

#### 2) **TX buffer state**

CTS will shift into inactive state only if the radio modem's TX buffer is in danger of overflowing. This typically happens when the serial interface data transfer speed is greater than the radio interface transfer speed and the size of transmitted messages is large.

### 5.2.2 CD-line

The options for CD-line are:

#### 1) **RSSI-threshold**

CD is active whenever a signal with a level exceeding the level required for reception exists on the radio channel. It doesn't make any difference if the signal is an actual data transmission, a signal of a radio transmitter not belonging to the system, or even an interference signal caused for example, by a computer or a peripheral device. CD is also active when the radio modem in question is transmitting.

## 2) Data on channel

CD will switch to active state only after recognition of a valid data transmission. CD will not react to interference signals.

## 3) Always ON

CD is always in the active state. This option can be used with terminal equipment, which use the CD-line as an indicator of an active connection (the radio modem can transmit and receive at any time).

### 5.2.3 RTS-line

The options for RTS-line are:

#### 1) Ignored

RTS-line status is ignored.

#### 2) Flow control

The radio modem transmits data to the terminal device only when the RTS-line is active. Non-active state of the RTS-line will force the radio modem to buffer the received data. This option is used if the terminal device is too slow to handle data received from the radio modem.

#### 3) Reception control

RTS-line controls the reception process of the radio modem. An active RTS-line enables reception (as normal). Non-active RTS-line will interrupt reception process immediately, even if the radio modem is receiving a data packet. This option is used to force the radio modem into WAIT State for an immediate channel change.

## 5.3 Timing and delays during data transmission

When using a radio modem for data transmission, certain delays will be formed through the use of a radio interface and from the radio modem circuitry itself. These delays exist when the radio modem switches from *Standby Mode* to *Data Transfer Mode* and during reception and transmission of data. For detailed delay values in each case see Appendix B.

### 5.3.1 Data buffering in the radio data modem

Whenever the radio modem is in *Data Transfer Mode* it monitors both the radio channel and the serial interface. When the terminal device starts data transmission the radio modem switches to transmission mode. At the beginning of each transmission a synchronisation signal is transmitted and this signal is detected by another radio modem, which then switches into receive mode. During the transmission of the synchronisation signal the radio modem buffers data into its memory. Transmission ends when a pause is detected in the data sent by the terminal device, and after all buffered data has been transmitted. When the serial interface speed is the same or slower than the speed of the radio interface, the internal transmit buffer memory cannot

overflow. However, when the serial interface speed exceeds the speed of the radio interface, data will eventually fill transmit buffer memory. In this instance, it will take a moment after the terminal device has stopped transmission of data for the radio modem to empty the buffer and before the transmitter switches off. The maximum size of transmit buffer memory is one kilobyte (1 kB). If the terminal device does not follow the status of the CTS-line and transmits too much data to the radio modem, the buffer will be emptied and the transmission is restarted.

In the receive mode, the buffer works principally in the above described way thus evening out differences in data transfer speeds. If the terminal device transmits data to a radio modem in receive mode, the data will go into transmit buffer memory. Transmission will start immediately when the radio channel is available.

### **5.3.2 Pause length**

The modem recognises a pause on the serial line (a pause is defined as a time with no status changes on the RS-232 interface TD-line). The pause detection is used as criteria for:

- End of radio transmission - When the transmit buffer is empty and a pause is detected, the modem stops the transmission and will then change the radio to the receive mode.
- SL-command recognition - For a SL-command to be valid, a pause must be detected before the actual "SL..." character string.
- User address recognition - In order for the start character to be detected, a pause must precede it in transmission.

Traditionally, in asynchronous data communication, pauses have been used to separate serial messages from each other. However, the use of non-real-time operating systems (frequently used on PC-type hardware) often adds random pauses, which may result in the user data splitting into two or more separate RF transmissions. This may cause problems especially in the systems including repeater stations.

In order to match the operation of the radio modem to the user data, the Pause length parameter can be adjusted on the programming menu. It may have any value between 3 and 255 characters. The default value is 3 characters.

Notes:

- The absolute time of Pause length is depending on the serial port settings. For example, 1 character is ~1.04 ms at 9600 bps / 8N1 (10 bits).
- The maximum absolute time is always 170 ms independent from the value of the Pause length given in the set-up.
- An increase in the Pause length increases the round trip delay of the radio link correspondingly; this is due to the fact that the radio channel is occupied for the time of the Pause length after each transmission (the time it takes to detect a pause). If this is not acceptable, the TX delay setting may also be useful in special cases.
- The software versions starting from 3.27 support adjustable Pause length; the previous versions use the fixed value of 3 characters.

### 5.3.3 TX delay

The radio modem can be configured to delay the beginning of a radio transmission by 1...65000 ms. This function can be used to prevent packet contention in a system, where all substations would otherwise answer a poll of a base-station simultaneously. During this delay data sent to the radio modem is buffered. Although the priority setting is "RX" (see chapter 3.3), radio modem is prevented to change over to receiving mode during the period of the TX delay. If this function is not needed, the delay time should be set to 0 ms.

## 5.4 Tests

The radio modem can be switched to the *Test Mode*, where it will send a test packet on the radio channel. The test packet is a normal data transmission, which can be used, for example, when directing antennas during system installation.

When the test packet transmission has been switched on and saved by using the *Programming Mode*, the transmitting radio modem needs only a power supply and an antenna.

If the channel spacing of the radio modems is 25 kHz, it is recommended to use 38400 bps as a serial data speed of the receiving radio modem. In the case of 12.5 / 20 kHz channel spacing the data speed of 19200 bps is recommended.

There are two *Test Modes*:

### **Short data block test**

In this test mode the radio modem sends a short test string, which is preceded by a consecutive number, and it ends to the line feed character. The short data block is repeated continuously after 1 s break.

Short data block test is suitable for running data communication tests. Error-free reception of data can be monitored using a suitable terminal program.

### **Example of a short data blocks:**

```
00 This is a testline of SATELLINE-3AS radio modem
01 This is a testline of SATELLINE-3AS radio modem
02 This is a testline of SATELLINE-3AS radio modem
```

### **Long data block test**

Long data block consists of character strings, which are repeated without breaks 50 s time period. After 10 s break the test transmission is started again.

Long block data test can be used for measuring Tx output power, standing wave ratio (SWR) of the antenna system or received signal strength at Rx stations. Please note that SATELLINE-3AS Epic has to be the version equipped with a cooling element if Long block data test is set on at higher than 1 W Tx output power.

**Example of a long data blocks:**

```
This is a long testline of SATELLINE-3AS radio modem  
This is a long testline of SATELLINE-3AS radio modem  
This is a long testline of SATELLINE-3AS radio modem
```

The strength of the received signal can be monitored using the LCD-display of the receiving radio modem or by measuring the voltage level of pin RSSI.

**NOTE 1!** Green TD led indicates active test mode.

**NOTE 2!** Normal data transfer is not available while the Test mode is active. Remember to switch it OFF before starting the normal data transfer.

**NOTE 3!** Message Routing and FCS mode must be disabled (see chapter 9.1.7) in prior to set ON the Test mode.

## 6 REPEATER MODE AND ADDRESSING

Repeaters and addressing may be used to extend the coverage area of a radio modem network, and to direct messages to selected radio modems in the network. In large systems, with several repeaters and formed repeater chains, it is often practical to use routing instead of plain addresses. For more information on routing, see Chapter 7.

### 6.1 Repeater

In circumstances where it is necessary to extend the coverage area of a radio modem network, SATELLINE-3AS radio modems can be used as repeater stations.

The maximum size of a repeated data packet is 1kB (kilobyte). The *Repeater Function* is switched on using the *Programming Mode*. In the repeater mode the radio modem will function as a totally independent unit, which means that only a power supply and a suitable antenna are needed. Other devices are not necessary.

A radio modem acting as a repeater can also be used to receive and transmit data. In repeater mode the radio modem will transmit the received data to the serial interface in a normal fashion. The difference being that the received data will be buffered into the buffer memory. After reception the radio modem will re-transmit the buffered data using the same radio channel as in reception. Data received through the serial interface a radio modem in repeater mode will transmit normally.

The same network may include several repeaters, which operate under the same base station. Repeaters may also be chained; in which case a message is transmitted through several repeaters. In systems with more than one serially or parallelly chained repeater, addressing or routing protocol must be used to prevent a message ending up in a loop formed by repeaters, and to ensure that the message finally reaches only the intended radio modem.

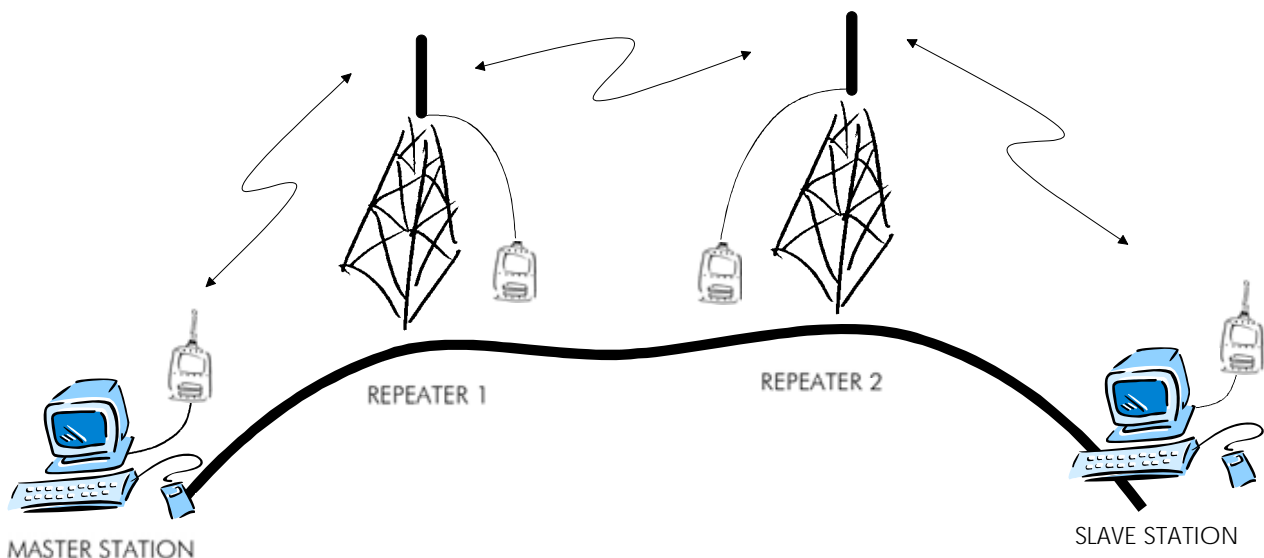

## 6.2 Addressing

Addresses can be used to route a data message to the desired destination or to separate two parallel networks from each other. In networks with repeaters it is usually necessary to use addresses to prevent data messages from ending up in loops formed by repeaters. In case of setting the "Message Routing" function in use, Tx / Rx addresses are ignored by the modem software.

SATELLINE-3AS radio modem allows the use of individual addresses both for reception and transmission. Addresses can be switched on separately, or simultaneously, in both data transfer directions.

The radio modem contains two transmission and two reception addresses, which are known as the primary address and secondary address. The primary address is used whenever data from the serial interface is transmitted. At the receiving end, the radio modem will receive using either of the two receive addresses.

**Secondary transmit address is only used in repeater applications.**

Radio modems configured to function as repeaters, will repeat data messages using either the primary or secondary address, depending upon which address was used during the reception of the data message.

**If only one address pair is needed in a network, both addresses must be set the same (TX1 = TX2 and RX1 = RX2).**

It is also possible to transfer the received address onto the serial interface.

The address is composed of two characters totalling 16 bits, resulting in over 65,000 different address combinations. The address is attached to the beginning of each data packet sent by the radio modem. When a radio modem receives a data packet whilst using addressing mode, the radio modem will check the first two characters of each received data packet to ensure that the packet in question was intended for the correct radio modem.

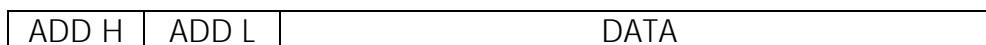

Address may be selected between 0000h...FFFFh (h = hexadecimal, corresponding decimal numbers are 0-65535).

**Example:** address 1234h (4660 in decimal format), where 12h is ADD H and 34h is ADD L.

**Example:** address ABFFh (44031 in decimal format), where ABh is ADD H and FFh is ADD L.

### Transmission:

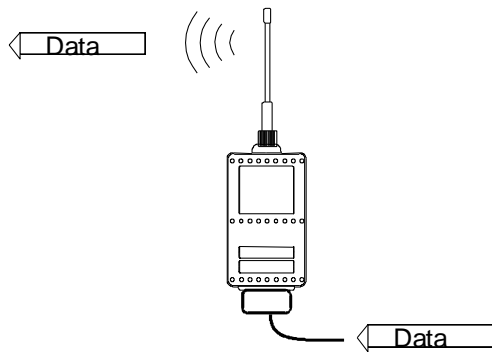

Transmission address has been set OFF. Radio modem will transmit the data packet as such.

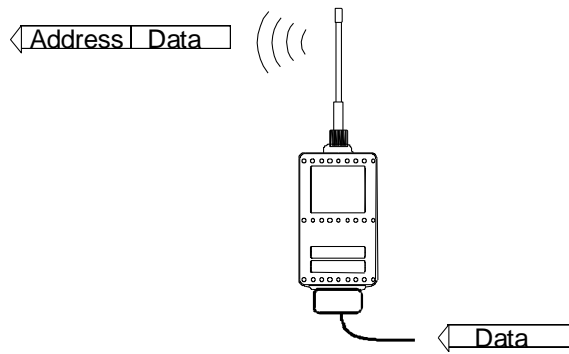

Transmission addressing has been set ON. The radio modem will add the primary TX address to the beginning of the data packet.

### Reception:



Reception addressing has been set ON and either the primary or secondary RX address of the radio modem is identical to the address of the received data packet.

The radio modem will remove the address and send the actual data to the RS-232 interface.

However, if the "RX Address to RD-line" setting is on, the radio modem does not remove the address.



Reception addressing has been set ON, but both the primary and secondary RX addresses of the radio modem are different from the address of the received data packet.

Data does not appear on the RS-232 - interface.

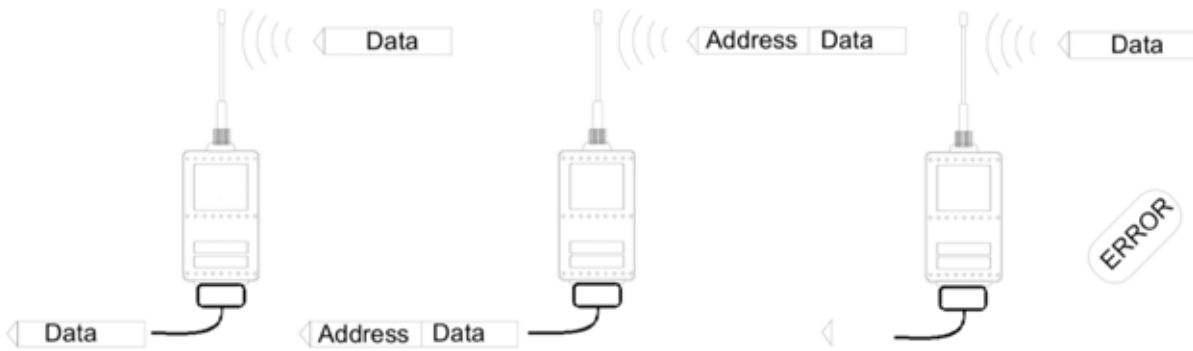

Reception addressing has been set OFF.

The radio modem will transfer all received data to the RS-232 interface.

Reception addressing has been set OFF.

The radio modem will consider the characters of the address as a part of the data and will send all the characters to the RS-232 interface.

Reception addressing has been set ON but there is no address in the data packet.

Data will appear on the RS-232 interface ONLY if the first 2 characters of the data match either of its own RX address. The radio modem will remove those 2 characters of data.

### 6.2.1 Connection between two points

When forming a connection between two points it is recommended that both the reception and transmission addresses are identical in both radio modems. This is the easiest way to control addresses and the risk caused by interference from other systems operating in the same area is minimal.

**Example:** by setting all addresses of both radio modems to a value '1234', they will accept only those messages which contain this address, and they will use this same value when transmitting data.

If the channel is reserved for use only by the said network, or if the terminal devices are responsible for addressing, it is not necessary to use addressing in the radio modems.

### 6.2.2 System of one base station and several substations

In systems with several substations, the base station must know to which substation each message is intended, and from which substation each received message originates. Usually terminal devices handle addressing completely, but it is also possible to use the addressing functionality of the radio modems.

For example, if the substation terminal devices are not able to check and form addresses by themselves, addressing may be achieved with the help of the addresses of the radio modems

attached to these terminal devices. The base station may, in such a case, define the destination of a message by adding the address of the corresponding radio modem into the beginning of the data packet. The substation radio modem(s) will check the address and the corresponding radio modem will identify and remove the address characters. In a similar way, the substation will add when transmitting to the base station its address characters into the beginning of the data packet, thus defining the origin of the sent data packet. In the base station radio modem, addresses have been switched OFF, so that they are transmitted as is to the base station terminal device for further processing.

### **6.3 Using repeaters and addresses in the same system**

In systems with several repeaters, a substation and a base-station, addresses must be used in radio modems. It is possible to realise also a system with only one repeater without addressing. In such a case, the base station will however hear the message both from the substation and from the repeater, in other words the message is duplicated as it moves along the route.

There are at least two ways of realising such a system depending on the capabilities of the terminal devices in question and on the number of repeaters to be used and on their relative positions to each other.

#### **6.3.1 System with several repeaters**

In systems with several serial or parallel-chained repeaters, addressing must be used to prevent messages from ending up in loops otherwise formed by repeaters, and to ensure that only the desired (addressed) radio modem receives the data intended for it.

All radio modems in the network must be set to a state, in which the RX-addressing is switched ON and TX-addressing is switched OFF. Base-station and all substations add an address string in the beginning of the data to be transmitted. In the relaying of the message addressing is used in the following way:

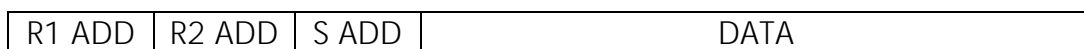

- The above is the data received from the base station terminal device, containing repeater addresses (R1 ADD, R2 ADD) and the substation address (S ADD). Two characters define each address.

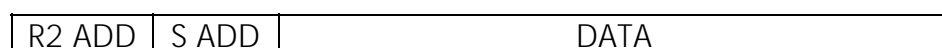

- The above is the same message after being relayed from repeater 1 to repeater 2.

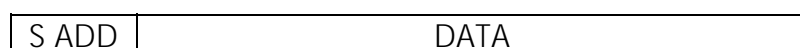

- The above is the same message after being relayed from the last repeater in the chain (repeater 2) to the substation.



- The above is the same message being relayed via the serial interface of the substation radio modem to the terminal device.

In a situation where the substation transmits data towards the base-station the address is formed in a similar way, but the order of the addresses is reversed:

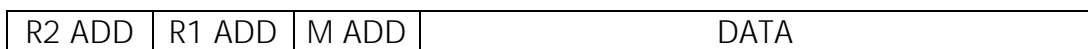

-In the above, R2 ADD is address of repeater 2, R1 ADD is address of repeater 1 and M ADD is the address of the base-station.

### 6.3.2 Repeater chain using address pairs

In a situation where the terminal devices and substations cannot form address fields, but are able to recognise messages addressed to them, alternating address pairs may be used. Transmit address (TX) and receive address (RX) alternate in the order shown in the table below.

Address type	Base-station address	Repeater 1 and the addresses of the substations of the base-station	Repeater 1 substations addresses
TX-address	Address 1	Address 2	Address 1
RX-address	Address 2	Address 1	Address 2

In a network where alternating addresses are utilised, the exact route that is used to relay a message to a certain radio modem is fixed at the time of installation and configuring the system. The order of the addresses must be the same as the order of the route that is used to relay the message to the said radio modem. It should be noted however, that in network where alternating addresses are used the base-station and substations will hear their own messages repeated.

### 6.3.3 Repeater chain using dual addressing

If the terminal devices cannot add address chains to the beginning of the data packets, a network with several repeaters may still be realised by using dual addressing. In dual addressing each link (see arrows below in figure) is given a unique address, which will prevent duplication of messages and endless loops in the network. The terminal devices need not add anything to the data.

Usually the primary transmit address is used in transmission (TX1). The secondary transmit address (TX2) is used only if the *Repeater Mode* is used and the packet to be repeated was received using the secondary reception address (RX2).

In the following example two repeaters are used. It should be noted that each link (arrow) might be uniquely defined with the help of radio modem numbers and data transfer directions. The *Repeater Mode* should be switched ON only in the radio modems acting as repeaters to prevent the packets from remaining in endless loops in the network.

Repeaters may also act as ordinary substations; in that case the terminal device must wait until the message has reached the end of the repeater chain before sending data.

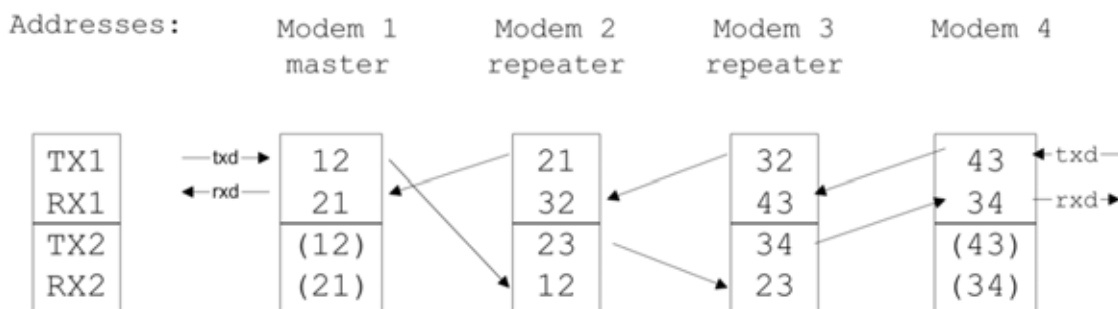

### 6.3.4 Redundant repeater chain

Reliability of a radio data communication system can be improved significantly by designing redundant equipment setup for master and repeater stations. The two repeater chains are separated by proper dual addressing setup. Slave stations need to be able to communicate with the master through the both repeater chains. By using the "TX address auto switch" function, the slave station modem directs the reply message to the repeater chain from which the request has been received.

If "TX address auto switch" has been set ON (see chapter 9.1.3), radio modem checks out the RX address of the received message. When one of the RX addresses is recognised, all the messages coming in from the serial interface will be sent to the air with matching TX address. The use of "TX address auto switch" function is not recommended if Repeater Function is set ON.

## 7 MESSAGE ROUTING

### 7.1 Introduction to Message Routing

*Message Routing* is an exciting feature in SATELLINE-3AS and Epic range. This feature allows messages from terminal devices to be automatically routed over the radio modem network to a specified recipient terminal.

In brief, the *Message Routing* works as follows:

- First, a radio modem reads any message coming from the terminal(s) attached to it.
- The radio modem detects the terminal address of the recipient, by seeking a pre-set position inside the message for the address.
- The radio modem checks its internal route table to see, if there is route information corresponding the address it has just found.
- The radio modem transmits a radio frame, which includes
  - the network id (see later)
  - the route information
  - the original user message encapsulated
  - redundant information such as checksums for error checking etc.
- The radio modems along the route relay the frame over the network to the radio modem at the destination.
- The radio modem at the destination first checks the validity of the received radio frame, then extracts the original user message, and finally outputs it the terminal device attached to it.

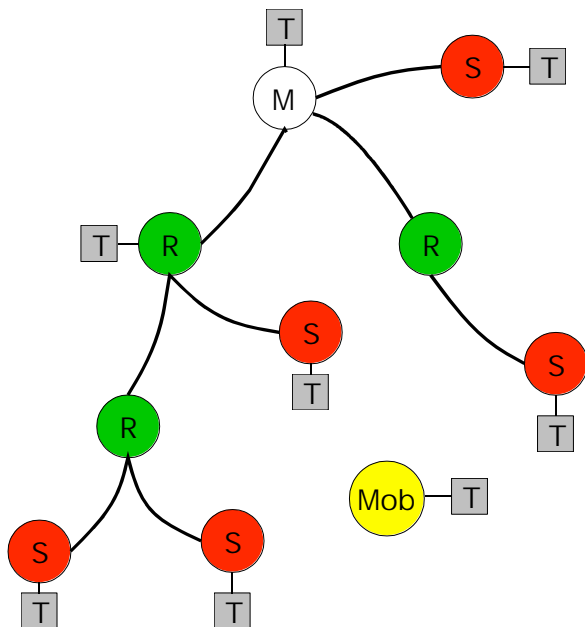

The figure left illustrates a possible structure of a radio modem network.

M = Master station (Central station)

R = Repeater station

S = Slave station

T = Terminal device

Mob = Mobile terminal

Terminals are usually PLC devices that send and receive messages according to a specific user protocol.

*Note:* The term *repeater* used in the context of the *Message Routing* should not be mixed with the *Repeater Mode*, which is a feature independent from the *Message Routing*.

### **7.1.1 Features of Message Routing**

The *Message Routing* feature of the SATELLINE-3AS and Epic is designed to be a fast and transparent to fit real time systems. The features include:

- Transparent to user protocols.
- Easy construction of a network containing several repeaters.
- Any radio modem may operate as a repeater, i.e. dedicated repeaters are not usually needed thus cutting down on costs.
- Large areas of coverage may be implemented by using only one radio channel.
- The use of mobile substations is also possible to some extent.
- The system will be fully deterministic i.e. the transmission delays are predictable. Because of that, the principle of *Message Routing* is connectionless.
- Added redundancy, as a failing radio modem can be, in certain cases, bypassed with another radio modem positioned in the same coverage area.
- *Message Routing* is intended mainly for the protocols based on polling scheme and a single master station.

### **7.1.2 Limitations of Message Routing**

- It is assumed that the position of the address field in the user messages is fixed. However some special protocols are supported:
  - IEC 60870-5-101 is a protocol commonly used in control applications of power lines.
  - RP570 protocol
- The message cannot end to the address; there must be at least one character after the address.
- It is assumed that there is only one message at a time inside the network simultaneous messages could cause collisions.
- The max number of the routes depends on the actual hardware and the software version.
- Operation of the Tx / Rx addresses is automatically blocked in the case of switching the "Message Routing" function on.

### **7.1.3 Getting started with Message Routing**

The design of any radio modem system requires very precise planning. Once the choices between devices, their location, installation, maintenance etc. are clear, the *Message Routing* for the system can be implemented.

Planning your Message Routing System

1. Decide which mode of the *Message Routing* suits the system - *Source Mode* or *Virtual Mode*. See the following paragraphs for details.
2. Design a layout of the system describing the settings such as protocol, addresses of the terminal equipment, radio frequencies and so on.
3. Configure the radio modems accordingly. There are two ways to configure the parameters related to the *Message Routing*:

1. *SaTerm* PC-program
2. Manual configuration in the setup menu.

In either case, please check the chapter on *Settings* before changing the setup of the radio modems.

Finally, when all the radio modems have correct settings, they are ready for further installation.

#### 7.1.4 *SaTerm* and the configuration of the Message Routing

*SaTerm* is a PC based program that allows the user to design their required network simply and quickly using a graphical interface to literally draw the network plan on the screen.

- o Firstly, a picture of the network is created to show all the radio modems and the intended route that the data is to take.
- o Secondly, the required settings are defined in the drawing.
- o Finally, the setup of each actual radio modem can be uploaded by connecting the actual radio modems one by one to the COM port, switching them to the programming mode, and clicking the transmit button of *SaTerm*.

Please check the user manual of *SaTerm* for more details.

The figure below shows a typical snapshot taken from a *SaTerm* screen.

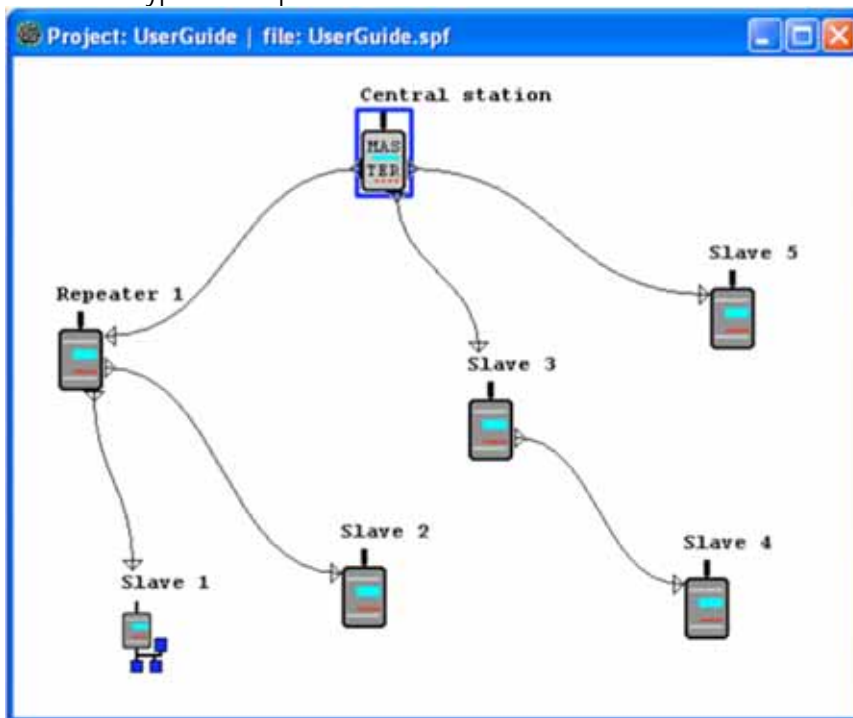

#### 7.1.5 Manual configuration of the Message Routing

The radio modems can be configured manually via the programming menu. However, this is recommended only if the structure of the network is very simple, or if it is desirable to define such special functions that are not possible to draw using the graphical interface of *SaTerm*. Examples of such cases are for example non tree-structured networks, or the use of same repeaters in several overlapping networks. The operation of the *Message Routing* must be clearly understood before configuring the radio modems manually.

### 7.1.6 Configuration of the protocol in Message Routing

A radio modem will detect the presence of an address used by inspecting the protocol from the message received via the serial interface. On the basis of this user address, all necessary information needed to relay the message to destination is fetched from an internal routing table inside a radio modem. The user protocol is not interpreted; instead, the user address is searched according to its location in the message. The beginning of the packet is located by a preceding pause in the byte stream. Message Routing can therefore be applied to most protocols with fixed address field position.

The position and length of the address is defined by two settings: *Offset* and *Length*.

- Offset defines the number of bytes (0...15) preceding the address.
- Length is the length of the address in the user protocol expressed in bytes (1...4).

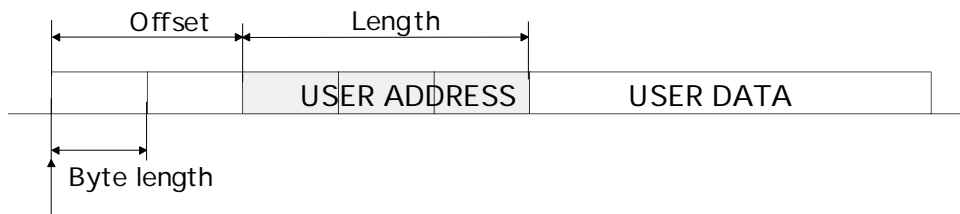

Start of data packet, Offset=2, Length=3

A transmitting radio modem adds a routing header and a tail to the user message. Consequently, a radio modem that receives the message removes the header and tail - so the Message Routing scheme is transparent to the user protocol.

## 7.2 Operating modes of Message Routing

The *Message Routing* has two different operating modes:

- o *Source Mode Routing*
- o *Virtual Mode Routing*

The most important differences between the two modes are shown in the table below.

Property	<i>Source Mode Routing</i>	<i>Virtual Mode Routing</i>
Summary	Slower, more functions	Faster, less functions
Radio interference tolerance	Yes, over hop function	No
Support for mobile stations	Yes	No
Addition of substations to a network	Only master station needs to be reconfigured	Master station and consecutive repeaters need to be reconfigured
Changing routes	Only master station needs to be reconfigured	All radio modems need to be reconfigured
Maximum length of route	16 hops	No limit
Over hop function	Yes	No
Network ID	Yes	Yes
Storing of routing information	Centralised	Dispersed
Message Routing overhead (bytes)	$10 + 2 * \text{number of hops}$	9
Maximum length of user protocol message (bytes)	1kB – Message Routing overhead	1kB – Message Routing overhead

Other issues common to the both modes:

- o The maximum number of terminals depends on the radio network structure and the number of routes.
- o Multiple terminal addresses may be attached to a radio modem.
- o The maximum length of a terminal address (in the user's protocol) is four bytes (FFFFFFFF in hexadecimal).
- o The maximum length of the address of a radio modem is two bytes (FFFF in hexadecimal).

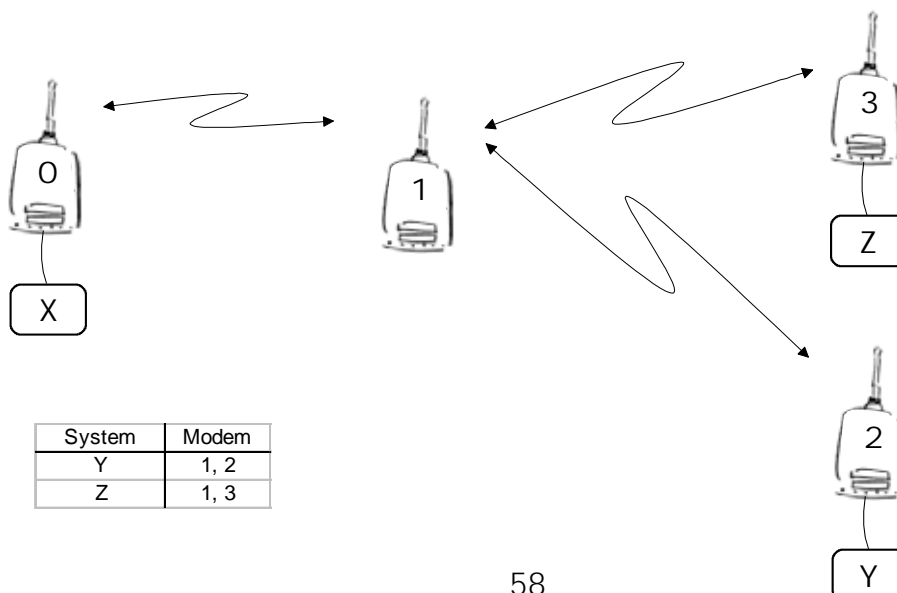

## 7.3 Detailed description of Message Routing

### 7.3.1 Source Mode Routing

The above figure represents a network containing four (4) radio modems. Each radio modem is given a unique address (0...3). A terminal device has been attached to the three of the four radio modems and they communicate with each other using terminal addresses X, Y and Z, respectively. Radio modem 0 and terminal device X together constitute the base station of the network and all routing information of the network has been programmed into this base station.

When the terminal device X transmits a packet to (e.g.) terminal Y, radio modem 0 will detect the address Y from the data received through the serial port. From the routing table a route 1,2 can be found to which the radio modem also adds its own address to define the route for return data. Radio modem 1 repeats the packet and radio modem 2 removes the address information from the received data packet thereby transferring only the original data to the serial interface. The address information received together with the packet is reversed (2, 1, 0) and saved to be use in the transmission of subsequent reply packets.

### 7.3.2 Virtual Mode Routing

Please contact SATEL for more information of Virtual Mode Routing.

### 7.3.3 Overhop function in Source Mode Routing

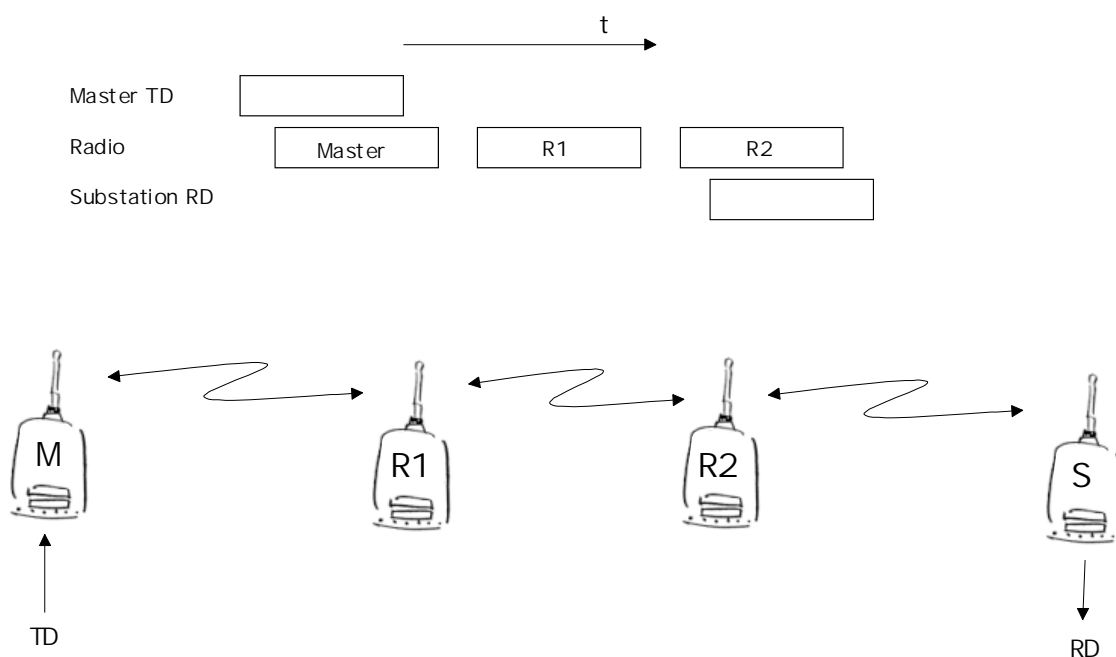

When using repeaters, the same packet is sent via a (radio) channel several times. A radio modem situated in the repeater chain will often hear other radio modems in addition to the immediate neighbouring radio modems. With *Source Mode Routing* the complete address information is sent together with the packets enabling the use of these secondary routes. Usually repeaters have better antennas (and/or antennas placed higher) than normal substations, which means that the distance between two repeaters can be much longer than the distance between a repeater and a substation.

Connections to other than the neighbouring stations of the repeater are not necessarily reliable under all possible (radio) conditions, but they can often be used to keep the network up and running at least partially should a repeater somewhere in the middle of the chain fail. In addition to this, the likelihood of a transmission error decreases if it is possible to listen to more than one transmission since; in this case, it is more likely that at least one of them will be received error-free. It is also possible, that the radio connection is asymmetrical due to the greater output power of a repeater or due to local interference; in which case, data can in fact travel in opposite directions using different routes.

When a repeater receives a message that contains its address but not as the first address in the address field, the packet is stored in a buffer. If the relayed message from the repeater, and the modem having sent the message originally, is not received (due for example, because of radio modem failure or if it has an erroneous checksum), the packet already buffered into the memory is re-sent without any change to the timing (no additional delays are introduced). Because of this, relatively short hop distances can be used, without the likelihood of errors being increasing due to the added number of repeats. A possible error in one of the repeaters does not necessarily cause a total breakdown of traffic.

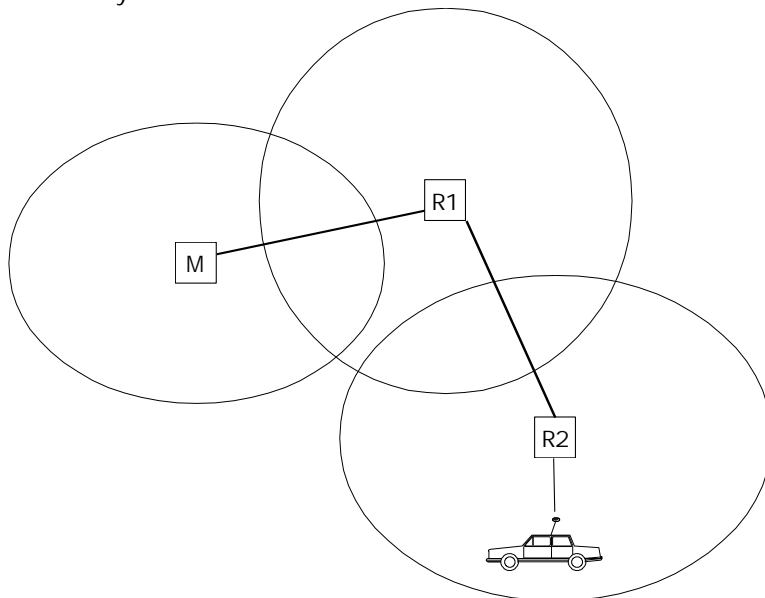

The over hop function allows for the use of mobile substations. In the example above, a mobile substation is first located in the coverage area of repeater R2. The route is defined as M, R1, R2 and vehicle. When the vehicle moves to the coverage area of repeater R1, the radio modem picks the packet already from the transmission of R1. This is then transferred to the serial port

using an additional delay, so that the timing does not differ from the first situation where the radio modem of the vehicle was in the coverage area of repeater R2. In this way a collision of the reply transmission and the transmission by repeater R2 is prevented. When the mobile station is transmitting, it is enough that at least one radio modem defined to be a part of the route receives the transmission.

#### 7.3.4 Network ID

The Network ID is a string of up to eight characters, which is used to prevent the reception of the messages coming from an external system. The radio modems operating in the same system using *Message Routing* must have the same Network ID. Only the messages that have a matching Network ID are received.

## 8 DIVERSITY RECEIVER SATELLINE-3AS(d) Epic

SATELLINE-3AS(d) Epic model has two antenna connectors, one solely for reception and the other for both reception and transmission. Diversity reception means that the radio modem selects the best signal from both those received by the two antennas. In this way the reliability of the connection is improved especially in those cases, which are subject to a high level of reflections and multipath fading.

### 8.1 Multipath fading

In radio systems (operating at suitable frequencies) it is not necessary to have a direct line-of-sight connection between the master station and a moving substation, because the radio signal propagates by reflecting from buildings and terrain contours e.g. hills. These useful reflections do however cause fading, which can occur when the radio signal experiences a number of reflections on the way to the receiving antenna. Radio signals propagate at the speed of light but if the signal is reflected from several different objects before reaching the receiving antenna the different total path lengths of these reflected signals will cause them to be detected at slightly different times. This means that these detected reflected signals are in different phases. In the worst-case scenario, two equally strong signals are in exactly opposing phases thus cancelling each other out and causing the signal level to drop.

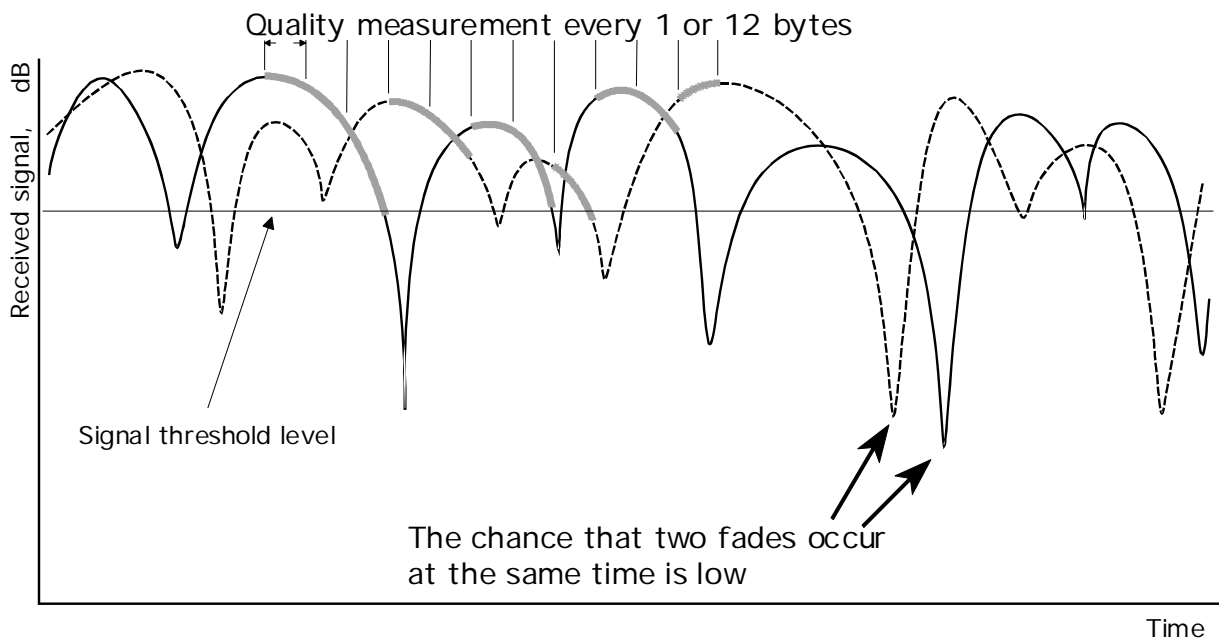

Received signals from two antennas. The selected signals are marked in grey.

## 8.2 Antenna installation

Space diversity = Two antennas are installed to different spatial positions.

Signal fading appears at half wave intervals and so the best results are achieved by installing the two antennas of SATELLINE-3AS Epic so that the minimum separation distance is  $\frac{3}{4}$  x wavelength used (min. 0.75 m). It is not recommendable to use Miniflex –antennas together with the SATELLINE-3AS Epic model.

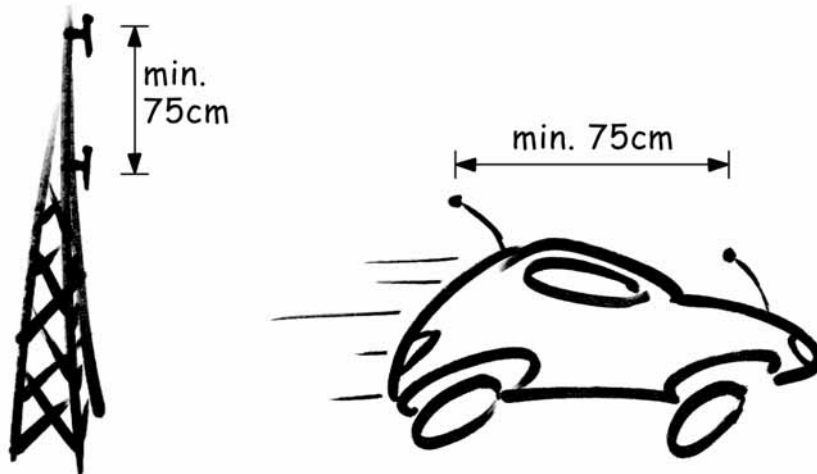

Polarization diversity = Two antennas are installed to the same location but with orthogonal polarizations.

## 9 SETTINGS

The configuration of SATELLINE-3AS radio modems can be easily changed. Simply by connecting pin 12 of the D-connector to ground (GND) the radio modem will switch into *Programming Mode*. Serial port **PORT 1** is used whenever the radio modem is in the *Programming Mode*. The serial port settings are 9600 bps, N, 8,1 (data transfer speed 9600 bps, no parity, character length 8 bits and one (1) stop bit).

SATELLINE-3ASd model contains push buttons and a LCD-display, which can be used to modify configuration settings without the help of an external terminal device. The radio modem will switch into *Programming Mode* by pressing the "SETUP"( ■ )button.

If the SL-command function has been activated active radio channel and addresses can be changed without switching the radio modem into *Programming Mode*. Serial port settings will remain as those defined previously when the radio modem was in *Programming Mode*.

### 9.1 Changing parameters using a terminal device

**PORT 1** of the radio modem is connected to a terminal device or a PC, which is in terminal emulation state. (This can be accomplished by using a suitable program such as the *SaTerm* program or the Windows™ Hyper Terminal program). Check the wiring of the serial port connection cable. Terminal device serial port settings must be set to 9600 bps, N, 8, 1 (data transfer speed 9600 bps, no parity, data length 8 bits and one (1) stop bit). MODE-pin (pin 12 of the D-connector of the radio modem) is then connected to ground (GND). Following this the radio modem will transmit the following message to the terminal (certain configuration settings might differ from the ones shown):

```

-----
          ***** SATELLINE-3AS *****
          SW version 3.XX / HW: uCE3/TC4x
-----
Current settings
-----
1) Radio frequency  XXX.XXXXX MHz ( CF XXX.XXXXX MHz, spacing 25kHz )
2) Radio settings   TX power 1000 mW / Signal threshold -112 dBm / FCS OFF /
                   TX start delay 0ms / Diversity RX OFF / EPIC PWRsave OFF /
                   Compatibility Satel 3AS / Call sign OFF
3) Addressing       RX address OFF / TX address OFF /
                   RX address to RS port OFF / TX address autoswitch OFF
4) Serial port 1    ON / 9600 bit/s / 8 bit data / None parity /
                   1 stop bit
5) Serial port 2    OFF / 9600 bit/s / 8 bit data / None parity /
                   1 stop bit ( RS-232 )
6) Handshaking      CTS Clear to send / CD RSSI-threshold /
                   RTS Ignored / Pause length 3 bytes
7) Additional setup Error correction OFF / Error check OFF / Repeater OFF /
                   SL-commands OFF / Priority TX / Full CRC16 check OFF /
                   User Data Whitening OFF
8) Routing          OFF
9) Tests            OFF
A) Restore factory settings
E) EXIT and save settings
Q) QUIT without saving

Enter selection >

```

### 9.1.1 Changing frequency (active radio channel frequency)

The frequency of the active radio channel can be changed by selecting main menu selection "1". In the example below the frequency is changed (468.2000 MHz -> 468.5250 MHz).

```
Enter selection >1

Radio frequency setup
-----
Active channel      468.2000 MHz
Lower limit band 1  466.2000 MHz
Upper limit band 1  470.2000 MHz
Lower limit band 2  466.2000 MHz
Upper limit band 2  470.2000 MHz
Channel spacing     25 kHz

Enter new frequency (MHz) or ESC to previous > 468.5250
```

A list of frequency values will appear on the screen updated with the new active radio channel frequency value:

```
Radio frequency setup
-----
Active channel      468.5250 MHz
Lower limit band 1  466.2000 MHz
Upper limit band 1  470.2000 MHz
Lower limit band 2  466.2000 MHz
Upper limit band 2  470.2000 MHz
Channel spacing     25 kHz

Enter new frequency (MHz) or ESC to previous >ESC
```

Maximum adjustment range of the active radio channel frequency is  $\pm 2$  MHz counting from the factory set centre frequency. Because of possible deviations in each country and/or region concerning the authorised use of the frequency spectrum local authorities may limit this adjustment range. SATELLINE-3AS radio modem can be supplied with the adjustment range divided into two bands (**Band 1** and **Band 2**), and this feature can be utilised in case it is required to limit the arbitrary adjustment of the active radio channel accidentally to a forbidden value. The centre frequency and the frequency band limiting values are factory set and the user cannot change them. The active channel is selected by entering a numerical value.

#### NOTE !

Adjustment of the active radio channel of the radio modem to frequencies other than those allocated and/or allowed by local authorities is strictly forbidden. Use or intended use of forbidden frequencies may lead to prosecution and penalties. SATEL is not responsible for any illegal use practiced with any devices manufactured and/or sold by SATEL and is not liable to pay any damages or compensation caused by such illegal use.

### 9.1.2 Changing radio settings

Radio settings which consist of transmitter output power and receiver sensitivity can be configured by selecting main menu selection "2". In the following example both the transmitter output power (1000 mW -> 20 mW) and the receiver sensitivity (-110 dBm->-90 dBm) are changed. Please note with SATELLINE-3AS Epic the output power alternatives are as follows: 1, 2, 5 and 10 W. Selection "4" (Diversity RX) is possible to set ON only with Epic modems.

```
Enter selection >2
Radio setup
-----
1) TX power                10 mW
2) Signal threshold        -110 dBm
3) TX start delay          0 ms
4) Diversity RX            OFF
5) Free channel scan       RX Slave / OFF
6) View hardware info
7) Radio compatibility      Satel 3AS

Enter selection or ESC to previous menu >1
TX power setup
-----
1) 10 mW
2) 20 mW
3) 50 mW
4) 100 mW
5) 200 mW
6) 500 mW
7) 1000 mW

Enter selection or ESC to previous menu >2
Enter selection or ESC to previous menu >2
Signal threshold setup
-----
Signal threshold -110 dBm

Enter new value (80 - 118) or ESC to previous menu > -90

Enter selection or ESC to previous menu >3
```

```
Set TX start delay setup
-----
TX start delay 0 ms
Enter new value (0 - 65535 ms) or ESC to previous menu > 100

Radio setup
-----
1) TX power                20 mW
2) Signal threshold        -90 dBm
3) TX start delay          100 ms
4) Diversity RX            OFF
5) Free channel scan       RX Slave / OFF
6) View hardware info
7) Radio compatibility      Satel 3AS

Enter selection or ESC to previous menu >ESC
```

The maximum useable sensitivity of the receiver is determined by the channel spacing (=radio interface data transfer speed) and also by error correction (utilised or not). For further information see Chapters 3.2, 10.3, 11.1 and 11.2.

In environments with high levels of interference, and when connection distances are short, it is often beneficial to use a "Signal threshold level" value, which is approximately 10 – 20 dBm above the maximum sensitivity level. This will prevent unnecessary receive attempts caused by noise.

**NOTE !**

The setting of the transmitter output power of the radio modem to levels in contradiction with transmitter power levels regulated by local or other governmental authorities is strictly forbidden. Use or intended use of forbidden transmitter power levels may lead to prosecution and penalties. SATEL is not responsible for any illegal use practised with any devices manufactured and/or sold by SATEL and is not liable to pay any damages or compensation caused by such illegal use.

When using SATELLINE-3AS Epic the diversity RX or the power save can be set ON by selecting 4) Diversity RX from the menu.

```
Diversity mode
-----
1) Diversity RX OFF
2) Diversity RX ON

Enter selection or ESC to previous menu >2
```

Free channel scan settings can be set by choosing the 6) Free channel scan from the menu. The options are as follows:

```
Free channel scan settings
-----
1) Free scan mode          OFF
2) Type of modem          RX Slave
3) FCS net ID             0000
4) Rx listen timeout      500ms
5) Channel hop threshold  -110 dBm
6) Beacon interval        1000 ms
7) Beacon disable timeout 0
8) Add new frequency to list
9) Show free scan frequency list
A) Clear frequency list

Enter selection or ESC to previous menu >
```

The hardware information can be seen by selecting 7) View hardware information. The menu is as follows:

```
Current hardware info
-----
Product version:      xxxx
Logicboard name:      xxxx
Logicboard version:  xxxx
Radioboard name:      xxxx
Radioboard version:  xxxx
```

### 9.1.3 Changing addressing settings (primary and secondary RX- and TX-addresses)

Addressing can be switched ON or OFF with the help of main menu selection "3". In the following example a primary RX-address (receiver address) is switched ON and the corresponding hexadecimal address value is modified ("0000" -> "0020"). The current values of the parameters are displayed and changed in toggle-type fashion by selecting the appropriate parameter selection number from the list displayed. The next menu level will then enable the modification of the values (within allowed limits). Modification of all other primary and secondary transmitter and receiver addresses is done in similar way.

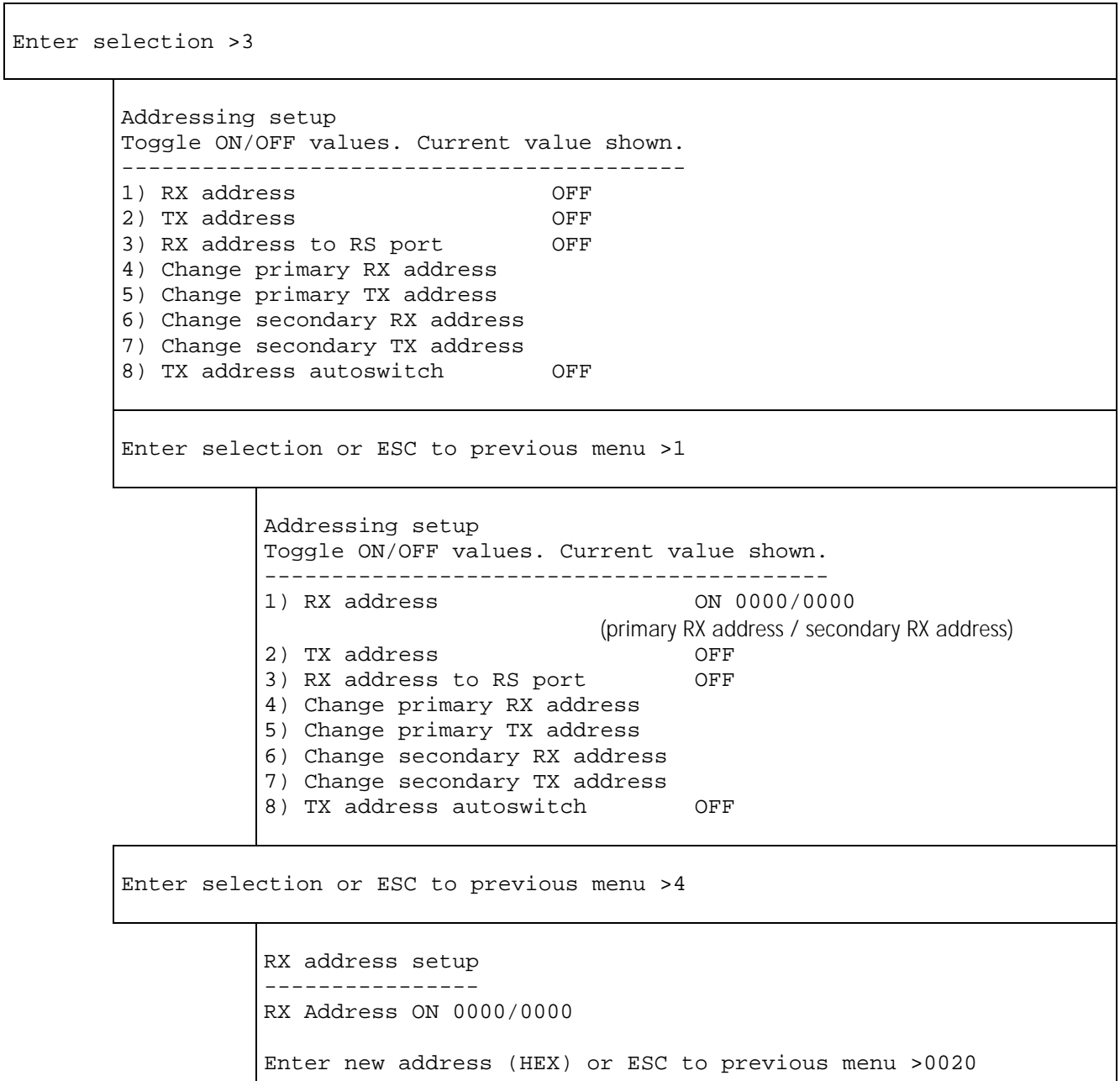

The new value is displayed in the menu:

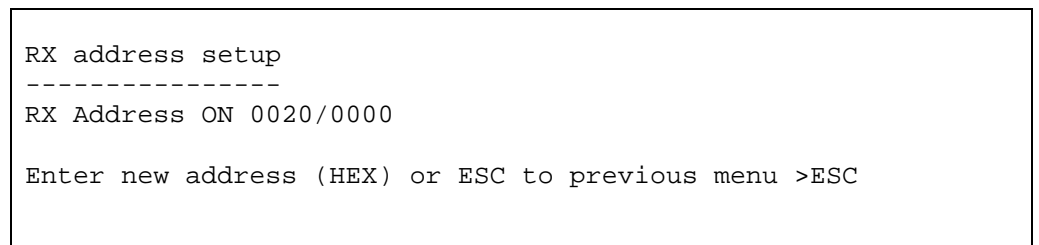

The address is given in hexadecimal format with four digits and the number of different addresses is thus over 65 000.

## Changing serial port settings (Port 1 and Port 2)

The settings of serial port **PORT 1** can be modified by selecting main menu selection "4" and the settings of serial port **PORT 2** by selecting "5". In the following example, PORT 1 will be switched to a non-active state, then the data transfer speed is modified (19200 bit/s -> 9600 bit/s), followed by the modification of the number of data bits (8 -> 7), then the number of parity bits (NONE -> EVEN) and finally the number of stop bits is changed (1 -> 2).

```
Enter selection >4

Serial port 1
Settings
-----
1) Port status      ON
2) Data speed      19200 bit/s
3) Data bits       8 bit data
4) Parity bits     None parity
5) Stop bits       1 stop bit

Enter selection or ESC to previous menu >1

Serial ports 1 and 2 status setup
-----
1) Port 1 ON / Port 2 OFF
2) Port 1 OFF / Port 2 ON

Enter selection or ESC to previous menu >2

Serial port 1
Settings
-----
1) Port status      OFF
2) Data speed      19200 bit/s
3) Data bits       8 bit data
4) Parity bits     None parity
5) Stop bits       1 stop bit

Enter selection or ESC to previous menu >2

Serial port 1 data speed
-----
1) 300 bit/s
2) 600 bit/s
3) 1200 bit/s
4) 2400 bit/s
5) 4800 bit/s
6) 9600 bit/s
7) 19200 bit/s
8) 38400 bit/s

Enter selection or ESC to previous menu >6
```

```
Serial port 1
Settings
-----
1) Port status      OFF
2) Data speed      9600 bit/s
3) Data bits       8 bit data
4) Parity bits     None parity
5) Stop bits       1 stop bit

Enter selection or ESC to previous menu >3
```

```
Serial port 1 data Bits
-----
1) 7 bit data
2) 8 bit data
3) 9 bit data

Enter selection or ESC to previous menu >1
```

```
Serial port 1
Settings
-----
1) Port status      OFF
2) Data speed      9600 bit/s
3) Data bits       7 bit data
4) Parity bits     None parity
5) Stop bits       1 stop bit

Enter selection or ESC to previous menu >4
```

```
Serial port 1 parity bits
-----
1) None  parity
2) Even  parity
3) Odd   parity

Enter selection or ESC to previous menu >3
```

```
Serial port 1
Settings
-----
1) Port status      OFF
2) Data speed      9600 bit/s
3) Data bits       7 bit data
4) Parity bits     Odd parity
5) Stop bits       1 stop bit

Enter selection or ESC to previous menu >5
```

```
Serial port 1 stop bits
-----
1) 1 stop bit
2) 2 stop bits

Enter selection or ESC to previous menu >2
```

Now all of the modifications of the example have been performed and the new values are displayed:

```
Serial port 1
Settings
-----
1) Port status      OFF
2) Data speed      9600 bit/s
3) Data bits       7 bit data
4) Parity bits     Odd parity
5) Stop bits       2 stop bits

Enter selection or ESC to previous menu >ESC
```

The settings of the serial port must be modified to correspond with the settings of the terminal device that is to be connected to the radio modem. Modification of the settings of serial port **PORT 2** is done according to the principle described above and by first selecting from the main menu selection "5". Additionally, the interface level of Port 2 can be set either to be RS-232, RS-422 or RS-485. See sub-menu below:

```
Serial port 2
Settings
-----
1) Port status      OFF
2) Data speed      9600 bit/s
3) Data bits       8 bit data
4) Parity bits     None parity
5) Stop bits       1 stop bit
6) Interface level RS-232

Enter selection or ESC to previous menu >6

Serial port 2 Interface setup
-----
1) RS-232
2) RS-485
3) RS-422
```

When installing SATELLINE-3AS(d) or SATELLINE-3AS(d) 869 into SATEL-321, please see chapter 1.5.1 Prepare installation of SATELLINE-3AS(d) modem into the SATEL-321 casing.

**NOTE!**

It should be noted that switching the radio modem into *Programming Mode* by connecting the MODE-pin (pin 12 of the D-connector) to ground (GND) will change the settings of serial port **PORT 1** to "9600,8,N,1" automatically irrespective of the serial port **PORT 1** DATA-mode settings.

### 9.1.4 Modification of handshaking functions

Handshaking related configuration settings can be modified by selecting the options from the main menu "6". In the following example characteristics of the CTS-line (CLEAR TO SEND -> TX BUFFER STATE), CD-line (RSSI-THRESHOLD -> DATA ON CHANNEL) and RTS-line (IGNORED -> FLOW CONTROL) are changed.

Enter selection >6	
Serial ports 1 and 2 Handshaking ----- 1) CTS line property      Clear to send 2) CD line property        RSSI-threshold 3) RTS line property      Ignored 4) Pause length            3 bytes Enter selection or ESC to previous menu >1	
	Select CTS line action property ----- 1) Clear to send 2) TX buffer state Enter selection or ESC to previous menu >2
Serial port 1 and 2 Handshaking ----- 1) CTS line property      TX buffer state 2) CD line property        RSSI-threshold 3) RTS line property      Ignored 4) Pause length            3 bytes Enter selection or ESC to previous menu >2	
	Select CD line action property ----- 1) RSSI-threshold 2) Data on channel 3) Always ON Enter selection or ESC to previous menu >2
Serial port 1 and 2 Handshaking ----- 1) CTS line property      TX buffer state 2) CD line property        Data on channel 3) RTS line property      Ignored 4) Pause length            3 bytes Enter selection or ESC to previous menu >3	

```
Select RTS line action property
```

- ```
-----  
1) Ignored  
2) Flow control  
3) Reception Control
```

```
Enter selection or ESC to previous menu >2
```

```
Serial port 1 and 2 Handshaking
```

- ```
-----  
1) CTS line property      TX buffer state  
2) CD line property      Data on channel  
3) RTS line property     Flow control  
4) Pause length         3 bytes
```

```
Enter selection or ESC to previous menu >4
```

```
Pause length
```

```
-----  
Current Setting: 3 bytes
```

```
Enter new value (3..255) to cancel > 4
```

Now all of the modifications of the example have been performed and the new values are displayed on the menu (see above):

```
***** SATELLINE-3AS *****
```

```
SW Version x.yz / HW: uCE3 / TC4x
```

```
-----  
Current settings
```

- ```
-----  
1) Radio frequency  468.5000 MHz ( CF 468.2000 MHz, spacing 25 kHz )  
2) Radio settings   Tx power level 20 mW / Signal threshold -90 dBm / FCS OFF /  
                    TX start delay 100 ms / Diversity RX OFF / EPIC PWRsave OFF /  
                    Compatibility Satel 3AS / Call sign OFF  
3) Addressing       RX address OFF / TX address OFF /  
                    RX address to RS port OFF / TX address autoswitch OFF  
4) Serial port 1    ON / 19200 bit/s / 8 bit data / None parity / 1 stop bit  
5) Serial port 2    OFF / 19200 bit/s / 8 bit data / None parity / 1 stop bit (RS-485)  
6) Handshaking      CTS TX buffer state / CD Data on channel /  
                    RTS Flow control / Pause length 4 bytes  
7) Additional setup Error correction OFF / Error check OFF / Repeater OFF /  
                    SL-commands OFF / Priority TX / Full CRC16 check OFF /  
                    User Data Whitening OFF  
8) Routing          OFF  
9) Tests            OFF  
A) Restore factory settings  
E) EXIT and save settings  
Q) QUIT without saving
```

```
Enter selection >
```

### 9.1.5 Special functions

Special functions are modified by selecting from the main menu selection "7". (For further information see the relevant Chapters describing the said functions). The current values of the parameters are displayed and can be modified in toggle-type fashion by choosing the appropriate parameter selection number from the list displayed. The next menu level will then enable the modification of the values (within allowed limits).

```
Enter selection >7
```

```
Additional set-up  
Toggle ON/OFF values. Current value shown.  
-----
```

- 1) Error correction   OFF
- 2) Error check       OFF
- 3) Repeater           OFF
- 4) SL-commands       OFF
- 5) Priority           TX
- 6) Full CRC16 check   OFF
- 7) User Data Whitening OFF

```
Enter selection or ESC to previous menu >ESC
```

### 9.1.6 Modification of routing

Configuration settings defining routing can be changed by selecting main menu selection "8".



```
User defined address position setup
-----
1) Start position      01
2) Length              01

Enter selection or ESC to previous menu >1

User defined address start position setup
-----
Current value: 01

Enter new start position (0-16) >02

User defined address start position setup
-----
Current value: 02

Enter new start position (0-16) >ESC

User defined address position setup
-----
1) Start position      02
2) Length              01

Enter selection or ESC to previous menu >2

User defined address length setup
-----
Current value: 01

Enter new length (1-4) >3

User defined address length setup
-----
Current value: 03

Enter new length (1-4) >ESC

User defined address position setup
-----
1) Start position      02
2) Length              03

Enter selection or ESC to previous menu >ESC
```

The display has now returned to the main menu of the routing settings and it can be seen that the routing mode (*Virtual Mode Routing*) as well as the protocol (USERDEFINED 02 03) have been modified.

Following this, a new address will be modified ("0009" -> "0002") and a new Network ID is defined ("testnet" -> "newname"):

```
Routing Setup
-----
1) Mode           Virtual routing
2) Protocol       Userdefined 02 03
3) Address        0009
4) Net id         testnet
5) Route list
6) Route add
7) Route delete
8) Delete all routes

Enter selection or ESC to previous menu >3

Address setup
-----
Current routing address 0009

Enter new address (HEX) or ESC to previous menu >0002

Address setup
-----
Current routing address 0002

Enter new address (HEX) or ESC to previous menu >ESC

Routing Setup
-----
1) Mode           Virtual routing
2) Protocol       Userdefined 01 01
3) Address        0002
4) Net id         testnet
5) Route list
6) Route add
7) Route delete
8) Delete all routes

Enter selection or ESC to previous menu >4

Net id
-----
Net id current value: testnet

Enter net id (8 char) or ESC to previous menu >newname

Net id
-----
Net id current value: newname

Enter net id (8 char) or ESC to previous menu >ESC
```

```
Routing Setup
-----
1) Mode           Virtual routing
2) Protocol       Userdefined 01 01
3) Address        0002
4) Net id         newname
5) Route list
6) Route add
7) Route delete
8) Delete all routes

Enter selection or ESC to previous menu >ESC
```

Selection "5" will produce a list of the routes:

```
Route list
-----
xxx
xxx
xxx

Press any key to return >
```

Selection "6" enables the addition of a route:

```
Route add
-----
Enter destination address (HEX) >
```

Selection "7" enables the removal of a route:

```
Route delete
-----
Enter destination address (HEX) >
```

Selection "8" enables erasure of ALL routing information simultaneously. The menu will then display the following text:

```
Routing Set-up
-----
1) Mode           Virtual routing
2) Protocol       Userdefined 02 03
3) Address        0009
4) Net id         testnet
5) Route list
6) Route add
7) Route delete
8) Delete all routes

Enter selection or ESC to previous menu >8

Do you really want to delete all routes?

Press Y key to delete or ESC to cancel >
```

### 9.1.7 Activating tests

Tests can be activated by selecting main menu selection "9". For more information on tests, see Chapter 5.4. Tests are activated by setting the status of the desired test to "ON" and will remain active until the value of the selection in the menu is returned to the value "OFF".

```
Enter selection >9
Tests setup
-----
1) Short block test      OFF
2) Long block test       OFF
```

**NOTE!** Message Routing and FCS mode must be disabled in prior to set ON the Test mode.

### 9.1.8 Restoring factory settings

Selecting main menu selection "A" can restore factory settings.

```
Enter selection >A
Restore factory settings
-----
Do you want to restore factory settings? (Y/N)>
```

Restoring is confirmed by pressing "Y" (Y=YES) or cancelled by pressing "N" (N=NO). Also the pressing of "ESC" button at any point in the procedure will return the display to the previous (next higher) menu level without restoring factory settings.

### 9.1.9 Saving modified settings into the permanent memory

All modified settings must be saved into the permanent non-volatile memory of the radio modem before switching out of the *Programming Mode*. Selecting the main menu selection "E" automatically saves the settings:

```
Enter selection >E
Configuration saved!
Please turn off program mode switch!
```

**NOTE!** To switch the radio modem back into *Data Transfer Mode* the MODE-pin of the D-connector (D15 pin 12) must be disconnected from ground (GND).

### 9.1.10 Updating software

The software of SATELLINE-3AS(d) is stored in a flash memory. If needed the software is easily updated by SaTerm terminal program. Please see the user guide of SaTerm for more details.

## 9.2 Changing parameters using the LCD-display

SATELLINE-3ASd contains a LCD-display that allows modification of the radio modems configuration settings without the use of an external terminal device. This is especially convenient when modifying or re-installing radio modems in the field. The radio modem is switched into *Programming Mode* by pressing the "SET-UP-button ( ■ ). First, the LCD-display will shortly display the model of the radio modem and the software revision information, after which it will automatically display the main menu, which is a list of the modifiable configuration settings.

The main menu is used to select the desired submenus, and the modifications are performed using these submenus. It is possible to jump back at any time to the previous (higher) level in the menu hierarchy by just pressing the "CANCEL"-button (or in some cases the "BACK"-button). Pressing the ▲ or ▼ button modifies parameters with numerical values consisting of digits. Use until the said digit (with the cursor blinking under it) has reached the desired value. In the case of numerical values the "NEXT"-button is used to move on to the next digit in the numerical value and then the above described process is used to modify it. The process is repeated until all digits in the value have been edited. Toggle-type parameters (typically with ON/OFF choices modifications have to be confirmed by pressing the "SELECT"- or "SET"-button.

This is the display in *Data Transfer Mode*. Serial port **PORT 1** settings are 19200, N, 8, 1. Frequency is set to 468.500 MHz. Signal strength info is displayed on the upper left-hand corner:

- RSSI value 0-102 (here -102 dBm) of the last received message or  
- current noise level e.g. n-115  
Battery level respectively on the upper right corner.

```
0-102  a11.5V  
  
468.5000 MHz  
COM1: 19200N81  
Setup
```

After pressing the "SET-UP-button the display will shortly show the model of the radio modem and the revision of the software.

```
SATELLINE-3AS  
Version 3.xx
```

The display will automatically then show the main menu, which is a list of modifiable parameters. Pressing the ▲ and ▼ buttons can move the cursor upwards and downwards. When the cursor > is placed beside the desired selection, entry into sub-menu is done by pressing the SELECT- button.

```
>RF frequency  
Radio settings  
Addressing  
Port 1  
Port 2  
Handshaking  
Additional  
Tests
```

```

Factory setup
Contrast

EXIT  ⏏ SELECT
    
```

### 9.2.1 Changing frequency (frequency of the active radio channel)

Press **⏏** or **⏏** until the cursor > points to "RF frequency" – selection and press "SELECT" to move onto the next submenu.

```

>RF frequency
Radio settings
Addressing
Port 1
Port 2
Handshaking
Additional
Tests
Factory setup
Contrast

EXIT  ⏏ SELECT
    
```

Press "CHANGE" if the frequency is to be modified.

```

Active channel
468.5000 MHz

BACK  ⏏ Change
    
```

**NOTE:** If you want to check possible frequency band limits and the center frequency (factory set values), press **⏏** and follow instructions given on page 66 (Checking the center frequency).

The cursor > will now blink under the first digit of the value indicating the center frequency (this first digit cannot be edited). To move onto the next digit, press "NEXT".

```

CF 468.5000 MHz
>468.2000 MHz
^
CANCEL ⏏ Next
    
```

---

```

CF 468.5000 MHz
>468.5000 MHz
^
CANCEL ⏏ next
    
```

Press **⏏** or **⏏** until the said digit has reached the desired value. Press "NEXT" to move on to the next digit and repeat the above-described steps.

Previous steps are repeated four (4) times.

Press **⏏** or **⏏**, until the last changeable digit has the desired value and confirm changes by pressing "SET".

```

:
:
CF 468.5000 MHz
>468.2000 MHz
^
CANCEL ⏏ SET
    
```

The radio modem will acknowledge changes if they are within acceptable limits ( $\pm 1$  MHz from the center frequency, and within optional band limits) with a similar message as shown on the right (frequency value depends on entered value). The display will return automatically to display the main menu (if the entered frequency is not acceptable an error message will be displayed).

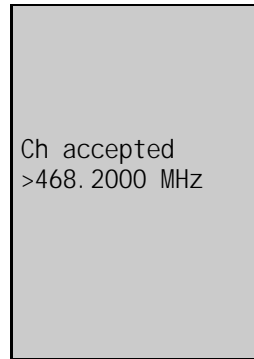

### CHECKING THE CENTER FREQUENCY

Press  $\uparrow$  or  $\downarrow$  until the cursor > points to "RF frequency" selection and then press "SELECT" to move to a submenu which can be used to check (or modify) the frequency.

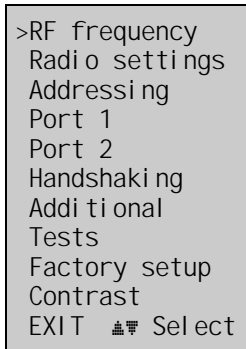

The current active channel frequency setting, is shown in the display. To check other related values press  $\downarrow$ . (To change the active channel frequencies press "CHANGE").

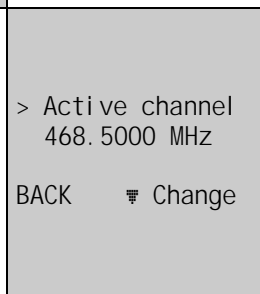

If  $\downarrow$  was pressed the display will now show the lower and higher limits of frequency **Band 1** (these values cannot be changed). (To change the active channel frequency value press "CHANGE").

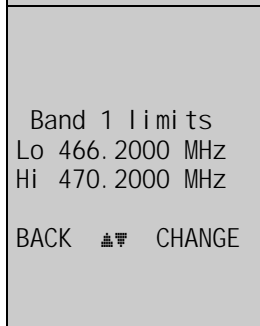

By pressing  $\downarrow$  again the display will show the lower and higher limits of frequency **Band 2** (these values cannot be changed). (To change the active channel frequency value press "CHANGE").

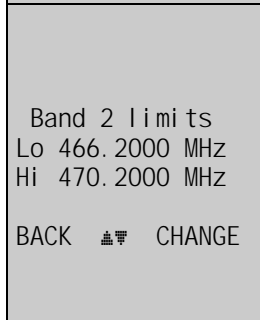

Press  $\leftarrow$  again and the display will return to show the center frequency (this value cannot be changed). (To change the active channel frequency value press "CHANGE").

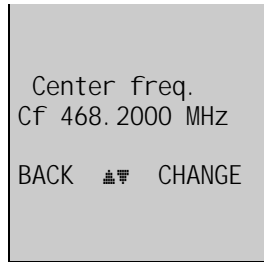

### Changing radio settings (transmitter power and receiver sensitivity)

Press  $\leftarrow$  or  $\rightarrow$  until the cursor > points to "Radio settings" selection and press "SELECT" to move on to the submenu.

RF frequency  
>Radio settings  
Addressing  
Port 1  
Port 2  
Handshaking  
Additional  
Tests  
Factory setup  
Contrast

EXIT  $\leftarrow$  SELECT

Press  $\leftarrow$  or  $\rightarrow$  until the cursor > points to the setting to be modified and press "CHANGE".

>TX level  
Sig. Threshold  
TX start delay  
Diversity RX  
Epic power save

BACK  $\leftarrow$  Change

MODIFYING TRANSMITTER OUTPUT POWER:  
The displayed list consists off all possible values of transmitter output power. Press  $\leftarrow$  or  $\rightarrow$  until the cursor > points to the desired value and press "SET".  
**NOTE:** The starting position of the cursor indicates the previously set value.

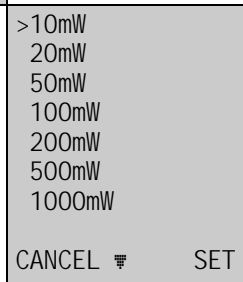

MODIFYING RECEIVER SENSITIVITY:  
The displayed list consists off all possible values of receiver sensitivity. Press  $\leftarrow$  or  $\rightarrow$  until the cursor > points to the desired value and press "SET".  
**NOTE:** The starting position of the cursor indicates the previously set value.

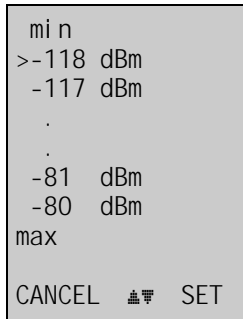

MODIFYING THE TRANSMIT START DELAY:  
The display will show the current value of the delay. Press "SET" to modify the value.

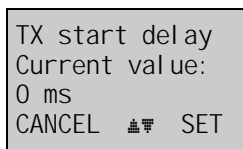

Press  $\Delta$  or  $\nabla$  until the first digit of the value has reached the desired value and then press "NEXT" to move on to the next digit.

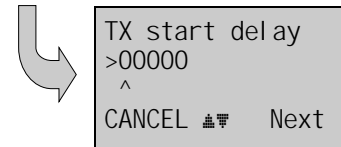

Repeat the above described five (5) times.

⋮

Press  $\Delta$  or  $\nabla$  until the last changeable digit has the desired value and finally confirm changes by pressing "SET".



Please note with SATELLINE-3AS Epic the output power alternatives are as follows: 1, 2, 5 and 10 W. Selections Diversity RX and Epic power save are possible to set ON only with Epic modems.

### 9.2.2 Changing addressing

Press  $\Delta$  or  $\nabla$  until the cursor > points to "Addressing" selection and press "SET-UP" to move on to the submenu.

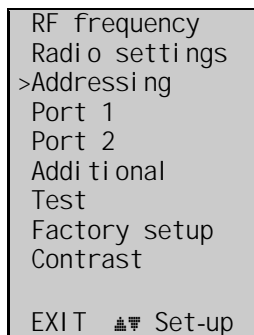

Select the desired submenu (RX or TX address) by pressing  $\Delta$  or  $\nabla$  and finally press "CHANGE".

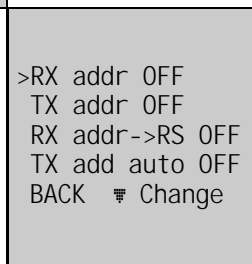

Press  $\Delta$  or  $\nabla$  until the first digit of the address has reached the desired value and move on to the next digit by pressing "NEXT".

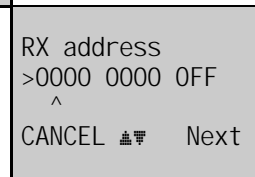

Repeat the above described eight (8) times.

⋮

Press NEXT again to jump to the toggle field (ON/OFF) and change the status to the desired value by pressing  $\Delta$  and  $\nabla$  until correct status is reached. Confirm the new address and status (ON/OFF state) by pressing "SET". The display will return to the previous (higher) level submenu.

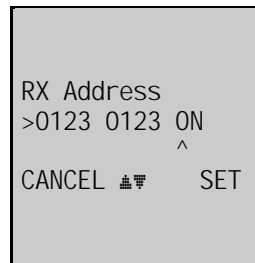

**NOTE:** Both RX and TX address modifications are done in the same way described above.

### 9.2.3 Changing serial port settings (Port 1 and Port 2)

Press  $\Delta$  or  $\nabla$  until the cursor > points to the desired port (in this example to **Port 1**) and move on to the submenu by pressing "SELECT".

```
RF frequency
Radio settings
Addressing
>Port 1
Port 2
Handshaking
Additional
Tests
Factory setup
Contrast
EXIT  $\Delta\nabla$  SELECT
```

Press  $\Delta$  or  $\nabla$  until the cursor > points to the setting to be modified and then press "CHANGE".

```
>ON
19200 bit/s
8 bit data
None parity
1 stop bit
BACK  $\Delta\nabla$  Change
```

#### MODIFICATION OF PORT STATUS:

Press  $\Delta$  or  $\nabla$  until the cursor > points to the desired port status. Confirm selection by pressing "SET". The display will return to the previous (higher) level submenu.

**NOTICE:** The starting position of the cursor indicates the previously set value.

```
>P1 ON / P2 OFF
P1 OFF / P2 ON

CANCEL  $\Delta\nabla$  SET
```

#### MODIFICATION OF DATA TRANSFER SPEED:

Press  $\Delta$  or  $\nabla$  until the cursor > points to the desired data transfer speed value (X bit/s). Confirm the selection by pressing "SET". The display will return to the previous (higher) level submenu.

**NOTE:** The starting position of the cursor indicates the previously set value.

```
300 bit/s
600 bit/s
1200 bit/s
2400 bit/s
4800 bit/s
9600 bit/s
>19200 bit/s
38400 bit/s
CANCEL  $\Delta\nabla$  SET
```

#### MODIFICATION OF THE NUMBER OF DATA BITS:

Press  $\Delta$  or  $\nabla$  until the cursor > points to the desired number of data bits (7 or 8 or 9 bit data length). Confirm the selection by pressing "SET". The display will return to the previous (higher) level submenu.

**NOTE:** The starting position of the cursor indicates the previously set value.

```
7 bit data
>8 bit data
9 bit data
CANCEL  $\Delta\nabla$  SET
```

#### MODIFICATION OF PARITY BITS:

Press  $\Delta$  and  $\nabla$  until the cursor > points to the desired parity bit status. Confirm the selection by pressing "SET". The display will return to the previous (higher) level submenu.

**NOTE 1:** The starting position of the cursor indicates the previously set value.

**NOTE 2:** If the number of data bits is set to 9, the value of parity bits must be set to NONE (no parity).

```
>None parity
Even parity
Odd parity
CANCEL  $\Delta\nabla$  SET
```

MODIFICATION OF THE NUMBER OF STOP BITS:  
Press  $\blacktriangle$  or  $\blacktriangledown$  until the cursor > points to the desired number of STOP bits. Confirm selection by pressing "SET". The display will return to the previous (higher) level submenu.

**NOTE:** The starting position of the cursor indicates the previously set value.

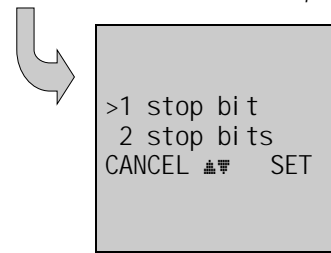

**NOTE:** Port 2 settings are modified correspondingly.

### 9.2.4 Modification of handshaking functions

Press  $\blacktriangle$  or  $\blacktriangledown$  until the cursor > points to "Handshaking" selection and move on to the submenu by pressing "SELECT".

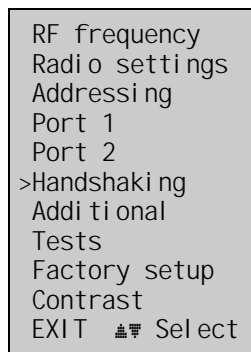

There are three (3) submenus relating to handshaking parameters. Press  $\blacktriangle$  and  $\blacktriangledown$  until the cursor > points to the desired submenu selection and press "CHANGE".

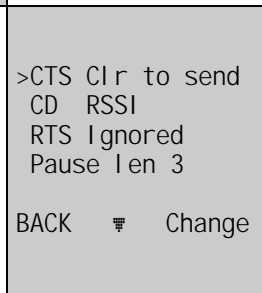

DEFINING CTS-LINE FUNCTIONS:  
Press  $\blacktriangle$  and  $\blacktriangledown$  until the desired function is indicated by the cursor > and confirm selection by pressing "SET". The display will return to the previous (higher) level submenu.

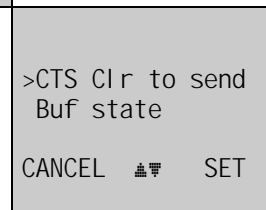

DEFINING CD-LINE FUNCTION:  
Press  $\blacktriangle$  and  $\blacktriangledown$  until the desired function is indicated by the cursor > and confirm selection by pressing "SET". The display will return to the previous (higher) level submenu.

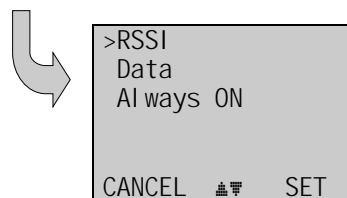

DEFINING RTS-LINE STATUS:  
Press  $\blacktriangle$  and  $\blacktriangledown$  until the desired function is indicated by the cursor > and confirm selection by pressing "SET". The display will return to the previous (higher) level submenu.

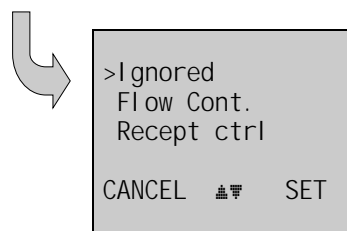

### 9.2.5 Selecting special functions

Press  $\blacktriangle$  or  $\blacktriangledown$  until the cursor > points to "Additional" selection and press "SELECT" to move on to the submenu.

```
RF frequency
Radio settings
Addressing
Port 1
Port 2
Handshaking
>Additional
Test
Factory setup
Contrast
EXIT  $\blacktriangle$  $\blacktriangledown$  Select
```

Press  $\blacktriangle$  or  $\blacktriangledown$  until the cursor > points to the setting to be modified. Press "CHANGE" to toggle the status of the said parameter from "ON" to "OFF" and vice versa. Press "CHANGE" until the parameter has the desired status. Repeat for all special functions to be modified and finally confirm all changes by pressing "BACK". The display will return to the previous (higher) level submenu.

```
>Error corr. OFF
Error check OFF
Repeater OFF
SL-commands OFF
Priority TX
Full CRC16 OFF
Data Whiten OFF

BACK  $\blacktriangle$  $\blacktriangledown$  Change
```

### 9.2.6 Activating tests

Press  $\blacktriangle$  or  $\blacktriangledown$  until cursor > points to "Tests" selection and press "SELECT" to move on to the submenu.

```
RF frequency
Radio settings
Addressing
Port 1
Port 2
Handshaking
Additional
>Tests
Factory set-up
Contrast
EXIT  $\blacktriangle$  $\blacktriangledown$  Select
```

Press  $\blacktriangle$  or  $\blacktriangledown$  until cursor > points to the test that is to be initiated. Press "CHANGE" to toggle the status of the selected test from "ON" to "OFF" and vice versa. After the tests have been set to desired states confirm all changes by pressing "BACK". The display will return to the previous (higher) level submenu. When the tests have been switched ON the TD led is green. Test signal will be activated by pressing BACK and saving the setting.

```
>Short Block OFF
Long Block OFF

BACK  $\blacktriangle$  $\blacktriangledown$  Change
```

### 9.2.7 Restoring factory settings

Press  $\uparrow$  or  $\downarrow$  to move cursor > to point to "Factory set-up" selection and press "SELECT" to move on to the submenu.

```
RF frequency
Radio settings
Addressing
Port 1
Port 2
Additional
Test
>Factory setup
Contrast
CANCEL  $\uparrow\downarrow$  Select
```

Press "YES" and all radio modem configuration settings will return to factory settings.  
**NOTE:** The display will show the question two (2) times to make sure that restoring factory settings is actually intended.

```
Do you want to
restore factory
settings?
NO      YES
```

### 9.2.8 Adjusting the contrast of the LCD-display

Press  $\uparrow$  or  $\downarrow$  to move the cursor > to point to "Contrast" selection and press "SELECT" to move on to the submenu.

```
RF frequency
Radio settings
Addressing
Port 1
Port 2
Additional
Test
Factory set-up
>Contrast
CANCEL  $\uparrow\downarrow$  Select
```

The display will show the current value of contrast. To modify contrast setting press "CHANGE".

```
Display contr. 3
BACK      Change
```

Press  $\uparrow$  or  $\downarrow$  until the cursor > points to the desired contrast level value. Confirm selection by pressing "SET". The display will return to the previous (higher) level submenu.

**NOTE:** The modified contrast value will actually take effect only after the radio modem is switched out from *Programming Mode* back into *Data Transfer Mode*.

**NOTE:** The starting position of the cursor indicates the previously set value.

```
1
2
>3
4
5
CANCEL  $\uparrow\downarrow$  SET
```

### 9.2.9 Saving modified values into the internal memory

After all desired modifications have been performed; they have to be saved in order to make them permanent (until next modification). This is accomplished by choosing selection "EXIT" from the main menu. The display will then show a message (see below) asking a confirmation of the performed modifications.

**By choosing "YES" all modifications are saved into the non-volatile memory inside the radio modem.** By choosing "NO" all modification performed are cancelled and previous settings remaining in the non-volatile memory.

Press "YES" to save all modifications into the non-volatile memory and "NO", if modifications are to be cancelled.

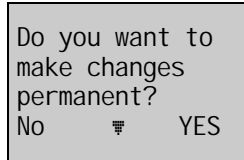

## 9.3 Changing parameters using the SL-COMMANDS

The controlling terminal device can change the configuration settings of a radio modem. This is accomplished with the help of SL-commands, which can be used during data transfer. SL-commands can be used to change e.g. the frequency or addresses. It is also possible to interrogate a radio modem in order to gain information concerning current settings that are in use. The terminal device is either a PC or a programmable logic (PLC) together with suitable (terminal) program. SL-commands must be enabled using *Programming Mode* before they can be used.

An SL-command is a one continuous string of characters, which is separated from other data by pauses that are equal or greater than time defined by Pause length parameter (see chapter 5.3.2) in the set-up. No extra characters are allowed at the end of an SL-command. Serial interface settings are the same as in data transfer and pin 12 of the serial connector **MUST NOT** be connected to ground (GND). SL-command is properly recognised also in the case when the command string is terminated in <CR> (=ASCII character no. 13, Carriage Return, 0x0d) or <CR><LF> (<LF> = ASCII char. no. 10, Line Feed, 0x0a). If multiple SL commands are sent to the radio modem the next command can be given after receiving the response ("Ok" or "Error") of the proceeding command. In addition, it is recommended to implement a timeout to the terminal software for recovering the case when no response is received from the radio modem.

When the power of a radio modem is switched off the configuration settings of a radio modem always return to values defined initially using the *Programming Mode*, thus resetting any settings changed using SL-commands during power on. It is however possible to save settings changed by using SL-commands and to make them the new configuration settings.

The radio modem will acknowledge all commands by returning an "OK" (command carried out or accepted) or the requested value, or an "ERROR" (command not carried out or interpreted as erroneous) message.

In case you need more information on the time delays related to the use of SL-commands, please contact the manufacturer.  
In order to get information of the special product variant specific SL-commands please contact SATEL Oy.

### 9.3.1 Frequency

| Command        | Effect and description of command                                                                                                                                                                                                                                           |
|----------------|-----------------------------------------------------------------------------------------------------------------------------------------------------------------------------------------------------------------------------------------------------------------------------|
| SL&F=nnn.nnnnn | Set frequency to nnn.nnnnn MHz                                                                                                                                                                                                                                              |
| SL&F?          | Display current frequency (response 'nnn.nnnnn MHz')                                                                                                                                                                                                                        |
| SL&C?          | Display center frequency (response 'nnn.nnnnn MHz')                                                                                                                                                                                                                         |
| SL&+=nn        | Set frequency nn channels above center frequency<br>Frequency = Center frequency + nn * Channel spacing, where nn=[0...Number of channels/2]                                                                                                                                |
| SL&-=nn        | Set frequency nn channels below center frequency<br>Frequency = Center frequency - nn * Channel spacing, where nn=[0...Number of channels/2]                                                                                                                                |
| SL&N?          | Display current frequency deviation from center frequency as channels<br>(Frequency - Center frequency)/Channel spacing (response '+nn' or '-nn')                                                                                                                           |
| SL&W?          | Display channel spacing (response 'nn.n kHz')                                                                                                                                                                                                                               |
| SL&D=x         | Sets the operational mode of the radio. The different values of x are:<br>"S" = Single Channel<br>"D" = Dual Channel<br>"R" = Reverse Dual Channel<br><b>Note!</b> Use this command only, if the setup of the frequency bands matches the Dual Channel operation.           |
| SL&D?          | Request the operational mode of the radio. The response is one of the following:<br>"S" = Single Channel<br>"D" = Dual Channel<br>"R" = Reverse Dual Channel<br><b>Note!</b> Use this command only, if the setup of the frequency bands matches the Dual Channel operation. |
| SL!D?          | Get lower limit of frequency band 1<br>Response "nnn.nnnnn MHz"                                                                                                                                                                                                             |
| SL!U?          | Get upper limit of frequency band 1<br>Response "nnn.nnnnn MHz"                                                                                                                                                                                                             |
| SL!W?          | Get lower limit of frequency band 2<br>Response "nnn.nnnnn MHz"                                                                                                                                                                                                             |
| SL!Y?          | Get upper limit of frequency band 2<br>Response "nnn.nnnnn MHz"                                                                                                                                                                                                             |

### 9.3.2 Addressing

xxxx = address in hexadecimal format (0000 ... FFFF)

| Command                    | Effect and description of command                                                                                                                                                                                   |
|----------------------------|---------------------------------------------------------------------------------------------------------------------------------------------------------------------------------------------------------------------|
| SL#I=xxxx                  | Set all addresses (RX1, RX2, TX1, TX2) to value xxxx                                                                                                                                                                |
| SL#I?                      | Display both primary addresses (TX1, RX1) (response 'xxxx;yyyy')                                                                                                                                                    |
| SL#T=xxxx                  | Set both transmit addresses (TX1, TX2) to value xxxx                                                                                                                                                                |
| SL#T?                      | Display primary transmit address (TX1) (response 'xxxx')                                                                                                                                                            |
| SL#R=xxxx                  | Set both receive addresses (RX1, RX2) to value xxxx                                                                                                                                                                 |
| SL#R?                      | Display primary receive address (RX1) (response 'xxxx')                                                                                                                                                             |
| SL#Q=x                     | Set TX address on x=1, off x=0                                                                                                                                                                                      |
| SL#Q?                      | Display status of the TX address (response '1' on, response '0' off)                                                                                                                                                |
| SL#W=x                     | Set RX address on x=1, off x=0                                                                                                                                                                                      |
| SL#W?                      | Display status of the RX address (response '1' on, response '0' off)                                                                                                                                                |
| SL#P=xxxx;yyyy             | Set primary transmit address (TX1) to value xxxx and receive address (RX1) to value yyyy                                                                                                                            |
| SL#S=xxxx;yyyy             | Set secondary transmit address (TX2) to value xxxx and receive address (RX2) to value yyyy                                                                                                                          |
| SL#P?                      | Display primary transmit address (TX1) and receive address (RX1) (response 'xxxx;yyyy')                                                                                                                             |
| SL#S?                      | Display secondary transmit address (TX2) and receive address (RX2) (response 'xxxx;yyyy')                                                                                                                           |
| SL#A=xxxx,yyyy, wwwww,zzzz | Set the addresses to values TX1=xxxx TX2=yyyy RX1=wwwww RX2=zzzz                                                                                                                                                    |
| SL#A?                      | Display all addresses (response 'xxxx, yyyy, wwwww, zzzz')                                                                                                                                                          |
| SLAxx                      | Set all addresses (RX1, RX2, TX1, TX2) to value xx [2 binary bytes]<br>NOT RECOMMENDED for new systems                                                                                                              |
| SLHnn                      | Set active frequency nn [0...99] channels above center frequency<br>Frequency = Center frequency + nn*Channel spacing<br>For conventional reasons, only 2 digit inputs are valid<br>NOT RECOMMENDED for new systems |
| SLLnn                      | Set active frequency nn [0...99] channels below center frequency<br>Frequency = Center frequency - nn*Channel spacing<br>For conventional reasons, only 2 digit inputs are valid<br>NOT RECOMMENDED for new systems |
| SLRxx                      | Set receive addresses (RX1, RX2) to value xx [2 binary bytes]<br>NOT RECOMMENDED for new systems                                                                                                                    |
| SLTxx                      | Set transmit addresses (TX1, TX2) to value xx [2 binary bytes]<br>NOT RECOMMENDED for new systems                                                                                                                   |

### 9.3.3 Radio parameters

| Command   | Effect and description of command                                                                                                                                                                                                                                                                                                                          |
|-----------|------------------------------------------------------------------------------------------------------------------------------------------------------------------------------------------------------------------------------------------------------------------------------------------------------------------------------------------------------------|
| SL@R?     | Display field strength of the last received message (the value is an average of many measurements made during the same reception).<br>Response "-xx dBm", where xx is a decimal value of the field strength and it is between -80 dBm and -118 dBm. Value available 7s after reception.<br>SATELLINE-3AS Epic returns the stronger value of two receivers. |
| SL@P=xxxx | Set the RF output power, where xxxx is the decimal value of the intended power in mW. If the given value does not correspond to one of the programmed power levels, the output power is set to the nearest possible value.                                                                                                                                 |
| SL@P?     | Requests the RF output power.<br>Response "xxxx mW", where xxxx is a decimal value the output power of the transmitter.                                                                                                                                                                                                                                    |
| SL@T=-xxx | Set the minimum power level of the signal to be received (= "Signal Threshold level"), where xxx is a decimal value of the new intended level in dBm.                                                                                                                                                                                                      |
| SL@T?     | Request of the current "Signal Threshold Level". Response is "-xxx dBm."                                                                                                                                                                                                                                                                                   |
| SL@D=x    | Set TX delay. Value x = 0...65535 ms                                                                                                                                                                                                                                                                                                                       |
| SL@D?     | Display TX delay value. Response 'x ms'                                                                                                                                                                                                                                                                                                                    |
| SL@F?     | Display the current noise level on the radio channel. Response "-xxx dBm".                                                                                                                                                                                                                                                                                 |
| SL@S=x    | Command selects the compatibility mode:<br>"SL@S=0" sets SATEL 3AS (default).<br>"SL@S=1" sets Option1 (PCC-4FSK)<br>"SL@S=2" sets Option 2 (PCC-GMSK)<br>"SL@S=3" sets Option 3 (TrimTalk GMSK)<br>The modem responds with "OK" message if the requested mode is supported, or "ERROR" if the mode is not allowed.                                        |
| SL@S?     | Enquires the active mode. The modem responds with a number:<br>"0" if the mode is SATEL 3AS<br>"1" if the mode is Option 1(PCC-4FSK)<br>"2" if the mode is Option 2 (PCC-GMSK)<br>"3" if the mode is Option 3 (TrimTalk GMSK)                                                                                                                              |
| SL@M?     | Get repeater function: "0" = Repeater OFF, "1" = Repeater ON                                                                                                                                                                                                                                                                                               |
| SL@M=x    | Set repeater function. Values of x are:<br>"0" = Repeater function OFF<br>"R" = Repeater function ON                                                                                                                                                                                                                                                       |
| SL%F?     | Get status of Error correction (FEC)<br>"0" = FEC OFF<br>"1" = FEC ON                                                                                                                                                                                                                                                                                      |
| SL%F=x    | Set Error correction (FEC). Value of x is:<br>"1" Set FEC ON<br>"0" Set FEC OFF                                                                                                                                                                                                                                                                            |

### 9.3.4 Other functions

| Command        | Effect and description of command                                                                                                                                                                                                                                                                                                                                                                                                                                                                                                                                                                                                                                                                                                                                                                                                                                                                                                                                                                                                                                                                                                                                                                                     |
|----------------|-----------------------------------------------------------------------------------------------------------------------------------------------------------------------------------------------------------------------------------------------------------------------------------------------------------------------------------------------------------------------------------------------------------------------------------------------------------------------------------------------------------------------------------------------------------------------------------------------------------------------------------------------------------------------------------------------------------------------------------------------------------------------------------------------------------------------------------------------------------------------------------------------------------------------------------------------------------------------------------------------------------------------------------------------------------------------------------------------------------------------------------------------------------------------------------------------------------------------|
| SL**>          | Save current settings as permanent settings.<br>This command must be used only seldom and under controlled conditions in order to avoid the corruption of the settings, which may happen in case the power supply fails in the middle of the memory save procedure.                                                                                                                                                                                                                                                                                                                                                                                                                                                                                                                                                                                                                                                                                                                                                                                                                                                                                                                                                   |
| SL%V?          | Display software revision information (response 'Vn.nn')                                                                                                                                                                                                                                                                                                                                                                                                                                                                                                                                                                                                                                                                                                                                                                                                                                                                                                                                                                                                                                                                                                                                                              |
| SL%D?          | Display modem type (response 'SATELLINE-3AS' or 'SATELLINE-3AS/EPIC')                                                                                                                                                                                                                                                                                                                                                                                                                                                                                                                                                                                                                                                                                                                                                                                                                                                                                                                                                                                                                                                                                                                                                 |
| SL%S?          | Display modem serial number (response 'nnnnnnnnnn' or 'No Serial nr')                                                                                                                                                                                                                                                                                                                                                                                                                                                                                                                                                                                                                                                                                                                                                                                                                                                                                                                                                                                                                                                                                                                                                 |
| SL%C?          | Customer specified information field. If not specified the response is 'No version id'. For more information please contact SATEL Oy.                                                                                                                                                                                                                                                                                                                                                                                                                                                                                                                                                                                                                                                                                                                                                                                                                                                                                                                                                                                                                                                                                 |
| SL%P=1         | Activate <i>Programming mode</i> without the use of PROG pin. Note that the serial port data speed remains the same as in the data transfer mode.                                                                                                                                                                                                                                                                                                                                                                                                                                                                                                                                                                                                                                                                                                                                                                                                                                                                                                                                                                                                                                                                     |
| SL%B?          | Requests the serial data parameters, response is a,b,c,d where<br>a= "38400", "19200", "9600", "4800", "2400" or "1200" (defines the baud rate)<br>b= "8", "7" or "9" (defines the character length)<br>c= "N", "E" or "O" (defines the parity)<br>d= "1" or "2" (defines the number of stop bits)                                                                                                                                                                                                                                                                                                                                                                                                                                                                                                                                                                                                                                                                                                                                                                                                                                                                                                                    |
| SL%B=a,b,c,d   | Sets the serial data parameters for data ports, where<br>a= "38400", "19200", "9600", "4800", "2400" or "1200" (defines the baud rate)<br>b= "8", "7" or "9" (defines the character length)<br>c= "N", "E" or "O" (defines the parity)<br>d= "1" or "2" (defines the number of stop bits)<br>Response is "OK" at the original baud rate.                                                                                                                                                                                                                                                                                                                                                                                                                                                                                                                                                                                                                                                                                                                                                                                                                                                                              |
| SL+P=xx        | Get the measured signal strength from the remote modem i.e. SL "ping".<br>If a remote radio modem is pinged the response is "OK, Modem xxxx rssi -80 dBm", where xxxx=RX1/RX2 address (in case the Tx/Rx addressing is configured) or the terminal address of the modem ( in case the Message Routing is ON).<br>"OK" is first received from the current radio modem to acknowledge that the SL-ping command has been interpreted correctly. The rest of the response will take a little longer to come, depending on the length of the radio link.<br>The remote radio modem that is to be pinged does not need to have SL-commands ON.<br>The value of the RSSI is between -118 and -80 dBm. If the signal strength is better than -80 dBm, -80 dBm is shown.<br>If the current radio modem is pinged, the response is "Local OK".<br>Please note that the SL-ping message will come out from the serial line of the radio modem that is pinged and also the repeater stations using the Tx/Rx addressing.<br>Note, SL-ping is a very short message so it may not give accurate results from the link condition. Even if the responses are good, channel interference may cause problems with longer data messages. |
| SL!B?          | Get beacon interval (ms), (decimal number)                                                                                                                                                                                                                                                                                                                                                                                                                                                                                                                                                                                                                                                                                                                                                                                                                                                                                                                                                                                                                                                                                                                                                                            |
| SL!B=n         | Set beacon interval, n is decimal number (ms)                                                                                                                                                                                                                                                                                                                                                                                                                                                                                                                                                                                                                                                                                                                                                                                                                                                                                                                                                                                                                                                                                                                                                                         |
| SL!C?          | Get number of channels in FCS list (decimal number)                                                                                                                                                                                                                                                                                                                                                                                                                                                                                                                                                                                                                                                                                                                                                                                                                                                                                                                                                                                                                                                                                                                                                                   |
| SL!C0          | Clear number of channels in FCS list                                                                                                                                                                                                                                                                                                                                                                                                                                                                                                                                                                                                                                                                                                                                                                                                                                                                                                                                                                                                                                                                                                                                                                                  |
| SL!F?nn        | Get frequency of FCS list channel nn (MHz) (Decimal number in MHz, for example "451.00000")                                                                                                                                                                                                                                                                                                                                                                                                                                                                                                                                                                                                                                                                                                                                                                                                                                                                                                                                                                                                                                                                                                                           |
| SL!F=nnn.nnnnn | Add new frequency to FCS list (MHz)                                                                                                                                                                                                                                                                                                                                                                                                                                                                                                                                                                                                                                                                                                                                                                                                                                                                                                                                                                                                                                                                                                                                                                                   |

|                    |                                                                                                                                                                                                                                                                                              |
|--------------------|----------------------------------------------------------------------------------------------------------------------------------------------------------------------------------------------------------------------------------------------------------------------------------------------|
|                    | Note: Use SL!C0 to clear list before creating an updated frequency list!                                                                                                                                                                                                                     |
| SL!I?              | Get FCS Net ID, "xxxx" [0000...ffff]                                                                                                                                                                                                                                                         |
| SL!I=xxxx          | Set FCS Net ID [0000...ffff]                                                                                                                                                                                                                                                                 |
| SL!L?              | Get channel hop threshold (dBm) i.e. RSSI trigger level for TX modem to change TX frequency<br>Command is irrelevant in version 3.34 or later - adaptive channel hop scheme has replaced setting's function                                                                                  |
| SL!L=n             | Set channel hop threshold (dBm) i.e. RSSI trigger level for TX modem to change TX frequency [-80...-118]<br>Command is irrelevant in version 3.34 or later - adaptive channel hop scheme has replaced setting's function                                                                     |
| SL!M?              | Get FCS (Free Channel Scanning) mode<br>"O" if FCS is OFF<br>"M" for master (=transmitter) without repeater in system<br>"S" for slave (=receiver) without repeater in system<br>"E" for master with repeater in the system<br>"R" for repeater<br>"H" for slave with repeater in the system |
| SL!M=x             | Set FCS mode. Values of x are:<br>"O" if FCS is turned OFF<br>"M" for master (=transmitter)<br>"S" for slave (=receiver).<br>"E" for master with repeater in the system<br>"R" for repeater<br>"H" for slave with repeater in the system                                                     |
| SL!N?nn            | Show last measured noise on channel nn (dBm)<br>Note: This command applies only to FCS Master modem<br>For example "-112 dBm"                                                                                                                                                                |
| SL!O?              | Get beacon disable timeout (seconds)                                                                                                                                                                                                                                                         |
| SL!O= n            | Set beacon disable timeout in seconds.<br>If it is zero then beacon is never disabled.<br>If timeout is less than beacon timeout, modem will not send additional beacons.                                                                                                                    |
| SL!R?              | Get RX listen timeout (ms)                                                                                                                                                                                                                                                                   |
| SL!R=n             | Set RX listen timeout (ms)                                                                                                                                                                                                                                                                   |
| SL!S?              | Get beacon time (ms) i.e. time beacon is sent after channel change                                                                                                                                                                                                                           |
| SL!S=n             | Set beacon time (ms) i.e. time beacon is sent after channel change                                                                                                                                                                                                                           |
| SL!T?              | Get frequency RSSI measure time for TX modem (ms)                                                                                                                                                                                                                                            |
| SL!T=n             | Set frequency RSSI measure time for TX modem (ms)                                                                                                                                                                                                                                            |
| SL!X?              | Get current transmit frequency                                                                                                                                                                                                                                                               |
| SL*R>              | Restore settings to their factory set values                                                                                                                                                                                                                                                 |
| SLSOS              | Save current settings as permanent settings<br>NOT RECOMMENDED for new systems                                                                                                                                                                                                               |
| SL!H?              | Get radio HW info: "HW:nnnnnn"                                                                                                                                                                                                                                                               |
| SL!V?              | Get modem "type"<br>Depending on variant, for example "3AS modem"                                                                                                                                                                                                                            |
| SL%C="text string" | Sets p/n (or other customer info) if it is empty (command works only once)<br>P/n must be stored to eeprom with command SL**> (Save settings)<br>Otherwise it will be lost when power is turned off                                                                                          |
| SL+ +?             | Get status of reception control<br>"0" = Reception enabled<br>"1" = Reception disabled                                                                                                                                                                                                       |

|        |                                                                                                                                                   |
|--------|---------------------------------------------------------------------------------------------------------------------------------------------------|
| SL+++  | Disable reception                                                                                                                                 |
| SL+O   | Enable reception                                                                                                                                  |
| SL+C?  | Get modem temperature in Celsius degrees<br>For example "-31", "-2", "7" or "No sensor" if not available                                          |
| SL+T?  | Get status of Transmitter tests<br>"0" = Transmitter tests are OFF<br>"1" = Carrier test is ON<br>"2" = Deviation test is ON                      |
| SL+T=x | Activate/Stop transmitter test. Value of x is:<br>"0" = Stop any transmitter test<br>"1" = Transmit Carrier test<br>"2" = Transmit Deviation test |

## 10 INSTALLATION

### 10.1 Installation of a radio data modem

The radio modem should be installed with the installation accessories supplied with the radio modem. There is also available an installation component for mounting the radio modem to a DIN-rail.

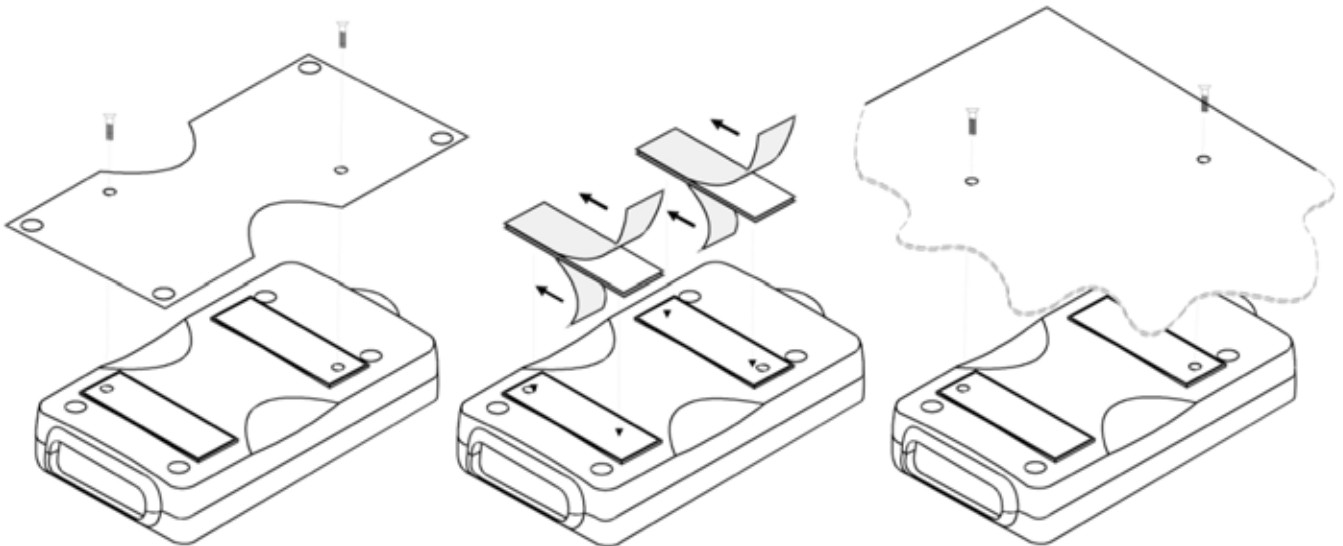

1. Installation with the installation plate supplied with the radio modem. The installation plate is fastened to the backside of the radio modem. The installation plate can be mounted using the holes provided on the plate.

2. Installation using the Velcro-tape provided with the radio modem.

3. Installation can also be made directly to customer's equipment.

#### NOTE!

When selecting a suitable location for the radio modem it must be ensured that no water can get into the radio modem under any conditions. Direct sunlight is also to be avoided. It is not recommendable to install the radio modem on a strongly vibrating surface. Suitable dampening and/or isolation materials should be used in cases where the installation surface will be subjected to vibration.

## 10.2 Connection cables

### NOTE!

When installing the cables of the serial interface, the operating voltage of all devices must be off (POWER OFF condition).

Due to the greater current consumption of SATELLINE-3AS Epic operating voltage must be connected to pins 14 AND 15, and ground to pins 7 AND 8. Correct fuse rating is in this case 4 A (SLOW FUSE).

### 10.2.1 RS-232 wiring

Basic RS-232 connection between the radio modem (PORT1) and a typical PC (COM-port):

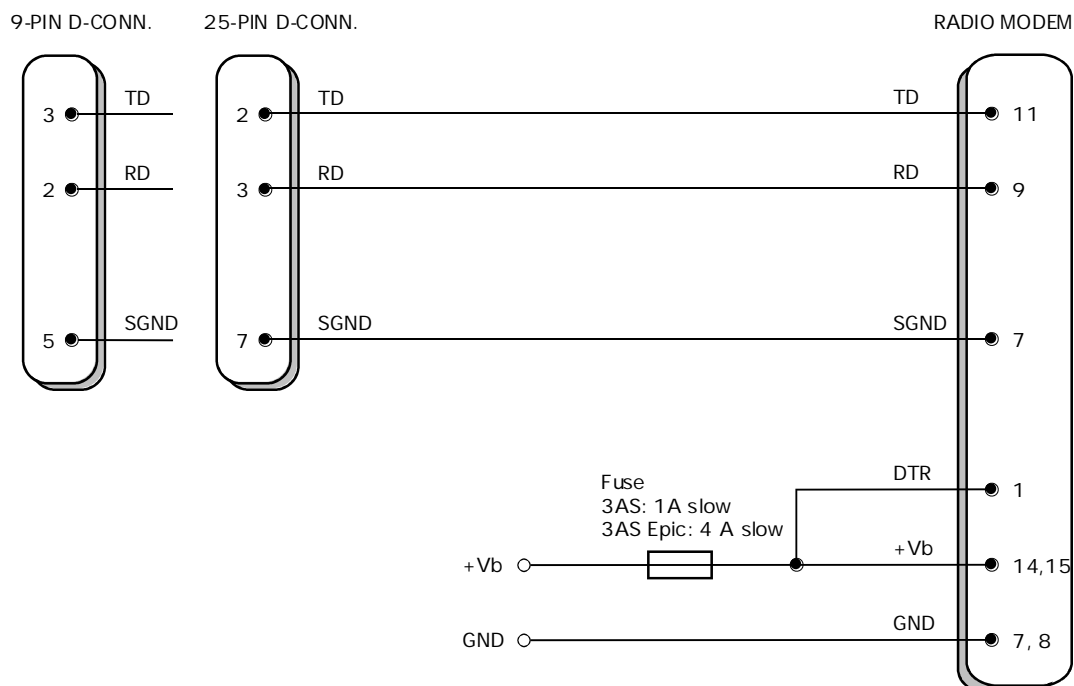

Basic RS-232 connection between the radio modem (PORT1) and a typical PC (COM-port) using handshaking:

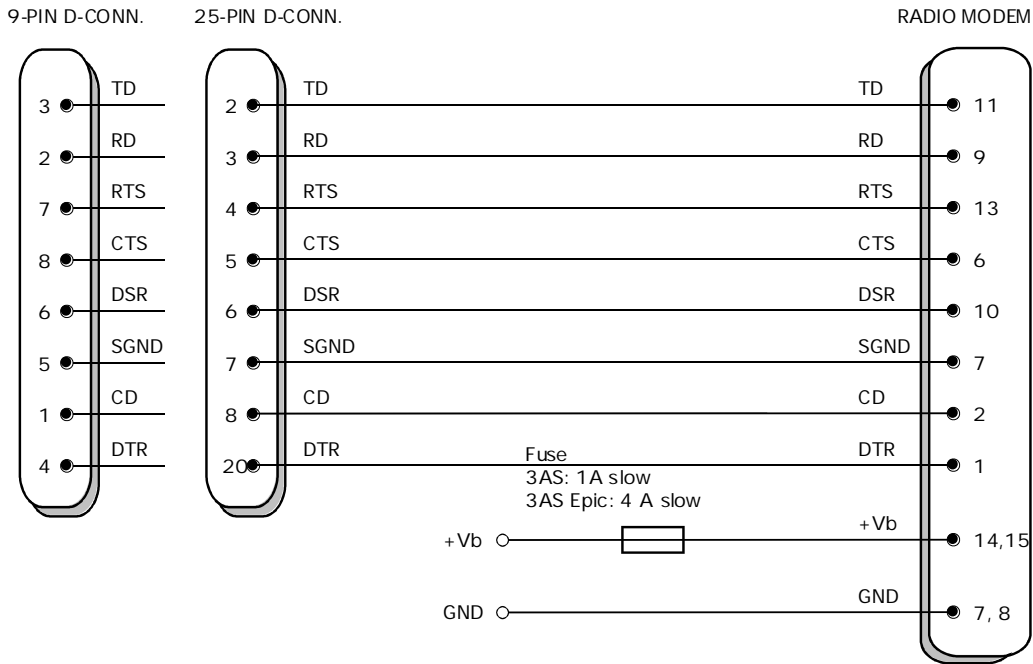

RS-232 connection between a radio modem (PORT2 in RS-232 mode) and a typical PC (COM-port):

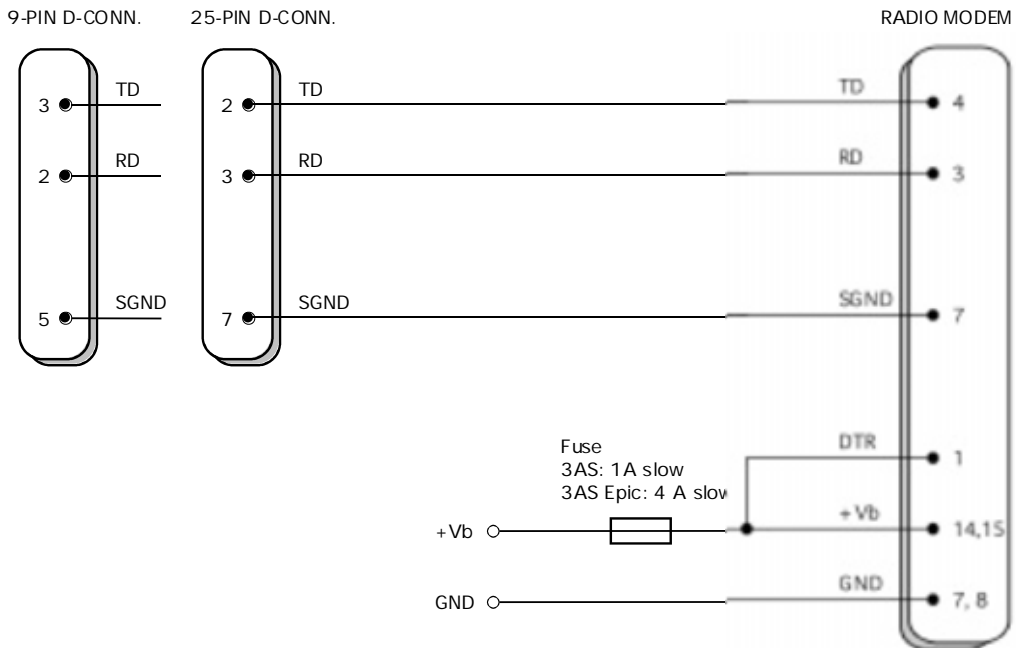

## 10.2.2 RS-422 wiring

PORT2 RS-422 connection:

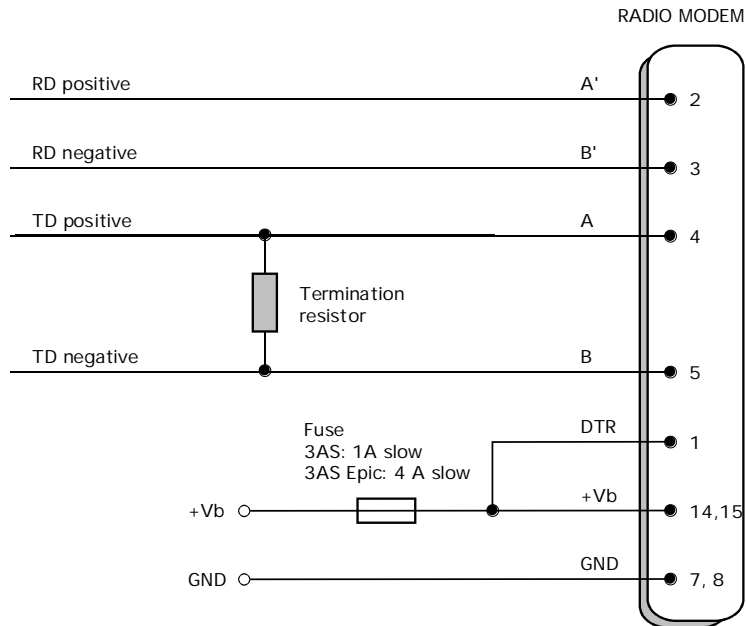

If the transmission lines are long the receiving end of the lines must be terminated using a separate termination resistor (typical values range from 100 -120 ohm depending on the characteristic impedance of the transmission line).

### 10.2.3 RS-485 wiring

PORT2 RS-485 connection:

Both ends of the transmission line must be terminated by connecting a separate terminating resistor between the positive and negative signal wire. Typical values range from 100 – 120 Ohm depending on the characteristic impedance of the line.

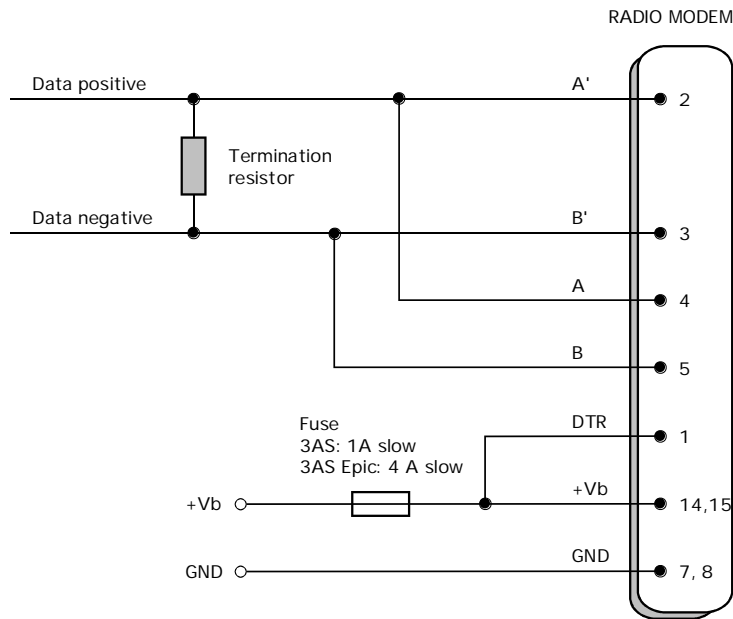

Connection to Profibus device

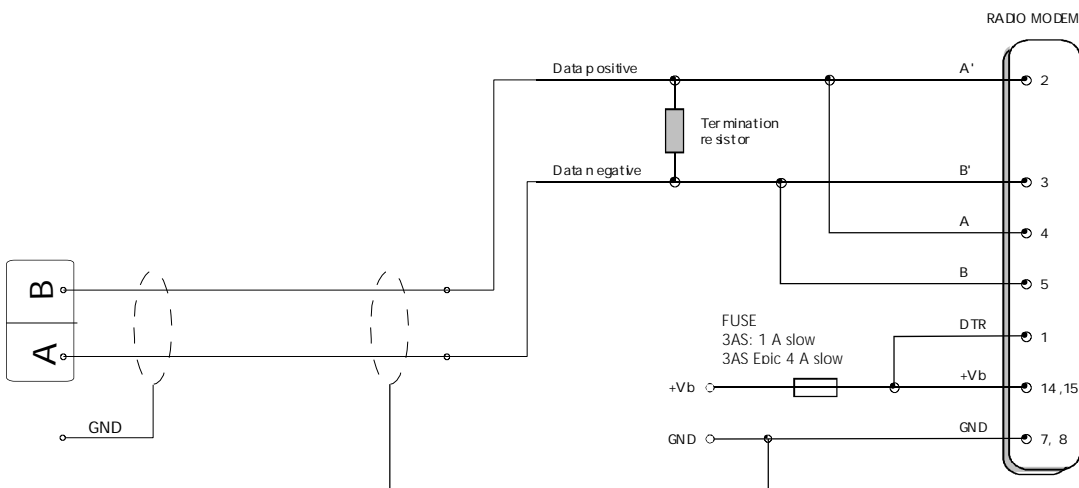

#### 10.2.4 Fuse

A proper fuse must be connected in between the radio modem and the power supply. The correct value depends on the model (see list below).

|                       | Fuse     |
|-----------------------|----------|
| SATELLINE-3AS(d)      | 1 A slow |
| SATELLINE-3AS(d) 869  | 1 A slow |
| SATELLINE-3AS(d) Epic | 4 A slow |

#### 10.2.5 Power supply

The allowed operating voltage is  $+9 \dots +30 V_{DC}$ . (SATELLINE-3AS Epic  $+11.8 \dots +30 V_{DC}$ ). The radio modem must only be connected to a power supply with an adequate current output (power rating minimum is 10W, with the Epic 50W). The pins 15 and 14 of the D-connector are connected to the positive power supply line. The pins 8 and 7 of the D-connector are connected to negative power supply line (ground).

The DTR-line of the radio modem, which is connected to pin 1, can be used as an ON/STANDBY –switch, and in this way the radio modem can be switched either ON (operational state) or OFF (STANDBY). The logical state "1" (more than +3 V) of the DTR-line corresponds to ON-state and a logical state "0" (0 V ... -15 V) corresponds to a STANDBY state.

In applications, where the radio modem is used as a portable device (meaning battery operation), the DTR-line (pin 1) should be connected to a logical state "0" always when it is possible to conserve battery power and prolong operational time between battery charging.

NOTE! There is a galvanic connection between signal ground (SGND, pin 7), ground (GND, pin 8), outer conductor of antenna connector and modem casing.

## 10.3 Antenna installation

### NOTE!

Because of the great transmission power of SATELLINE-3AS Epic radio modem, only an external antenna is allowed. A whip-antenna directly connected to the antenna connector must not be used.

### 10.3.1 Hand-held equipment

- ¼-wave antenna (wavelength at frequency of 450 MHz is approximately 70 cm)
- Helix-antenna

Antennas are installed directly to the TNC-type antenna connector at the upper part of the radio modem.

### 10.3.2 Mobile equipment

- ¼-wave antenna
- ½-wave antenna

The ideal installation position is vertical, and there should be at least 0.5 m of free space around the antenna. In small systems a ¼-wave antenna is sufficient. A separate ground plane should be placed under the antenna (vehicle rooftop or the engine hood or trunk door are usually suitable). In problematic cases the most suitable type is a ½-wave antenna. It can be installed directly at the top of a pipe with the added benefit of gaining as much as free space around the antenna as possible. In cases, which the antenna cannot be directly connected to the TNC-connector of the radio modem, a coaxial cable with 50 ohm impedance must be used between the antenna and the TNC-connector.

### 10.3.3 Base stations

- Omni-directional antennas (¼-, ½- or 5/8-wave antenna)
- Directional antennas (yagi /multi-element antenna or corner antenna)

The antenna should be installed in a vertical position. The exact location of the antenna depends on several factors, such as the size of the overall system and the coverage area terrain contours. A rule of thumb is that the base station antenna should be located at the highest point of the coverage area and as close to the centre of the coverage area as possible. The base station antenna can also be located inside a building, if the walls of the building do not contain metal.

### **10.3.4 General antenna installation instructions**

The reliability and the achievable coverage of useful signal strength can be severely affected by the positioning of the antenna. Antenna and cable connectors should have gold-plated pins and sockets, as use of low quality connectors can lead to eventual oxidation of the connector surfaces, which in turn may degrade the contact and cause additional attenuation. Good quality tools and materials must be used when installing radio modems, antennas and cables. The weather tolerance of the materials used must also be taken into account. Installed materials must withstand all foreseeable weather conditions (frost, excess sun, direct UV-radiation, seawater etc.). Also possible environmental pollution must be considered (acids, ozone etc.).

Antennas must be installed well away from metallic objects. In the case of small antennas this distance should be at least ½ m. With large antennas the distance should be >5 m and in case of repeater antenna combinations >10 m.

If the system contains a large number of radio modems, the best location for an antenna is the highest point of a building and possibly an additional antenna mast. If a separate antenna mast is used, the antenna can, if necessary, be installed sideways about 2...3 m from the mast itself.

When installing an antenna possible interference sources must be considered. Such interference sources are, for example:

- mobile telephone network base station antennas
- public telephone network base station antennas
- television broadcast antennas
- radio relay antennas
- other radio modem systems
- PC-related devices (approximately 5 m radius from antenna)

When ordering antennas we request you to note that antennas are always tuned to a specific frequency range. Simple antennas and antennas, which have been constructed of stacked yagi-antennas, are typically rather broadband. As the number of yagi-elements increases the frequency range becomes narrower.

When designing and installing a system it is advisable to prepare to test the system, and also to consider serviceability of the system. In particular cabling should be planned to allow easy access and to allow for maintenance. It is often practical to use long antenna cables, so that the radio modem can be installed far enough from the antenna itself to a location that is easily accessible (see section 10).

The type of the antenna cable is dependent on the length of the antenna cable, and the following table can be used to select a suitable type:

| Length  | Type      | Attenuation 10m/450MHz |
|---------|-----------|------------------------|
| < 5m    | RG58      | 3.0dB                  |
| 0...20m | RG213     | 1.6dB                  |
| > 20m   | ECOFLEX10 | 0.9dB                  |
| > 20m   | AIRCOM+   | 0.8dB*                 |
| > 20m   | ECOFLEX15 | 0.6dB                  |

\*) AIRCOM+ cable is partially air insulated, so the use of this cable requires that the connection between the cable and the connectors are fully airtight.

If there is a line-of-sight path between the antennas a 6 dB power marginal is usually adequate. However, if the connection is built on the reflection and/or the knife-edge diffraction the path loss can vary even 20 dB depending on the weather conditions. In this case a short test can give a too positive result of the quality of the connection. Thus the height of the antennas and topographical obstacles must be surveyed with great care. From time to time a marginal connection can be used if the data transmission protocol is well prepared for this and the data transmission that occasionally slows down does not cause any problems to the system.

Vertical polarised antennas (antenna elements are in vertical position) are often used in radio systems. In a system between a base station and substations vertical polarisation is recommended. The radio modem antenna cannot be mounted on the same level as the other substation antennas in the same building. The best way to distinguish from the other antennas situated in the neighbourhood is to mount the antennas as far a part as possible from each other on the altitude level. The best result is generally obtained when all the antennas are in the same mast. With an extra ground plane between the antennas more distinction can be obtained between the antennas in the mast.

Horizontal polarisation can be used in data transmission between two points. With the polarisation attenuation more distinction is obtained to vertical polarised systems. The influence of the directional patterns of the antennas must, however, be taken into consideration. If a distinction to another interfering antenna is wanted with the horizontal polarised antennas there must be a good attenuation of the back lobe. In addition to this the interfering radiator should be situated behind the antenna.

When a system does not demand the use of an omni-directional antenna it is recommended that directional antennas are used e.g. two-element yagis in permanent external installations. Please note that as antenna amplification increases the setting of the direction of the antenna requires more attention.

Base stations in high places should be supplied with high-Q cavity filters. Please note that the higher the base station antenna, the larger the coverage area and in turn that the risk of interference is also increased.

SATEL recommends the use of a band-pass filter with a large Q in the antenna cable of the base station.

**Example of an antenna installation:** by using amplifying antennas ( $G$ =Gain) and by installing the antenna high, long connection distances can be realised using the SATELLINE-3AS radio modem.

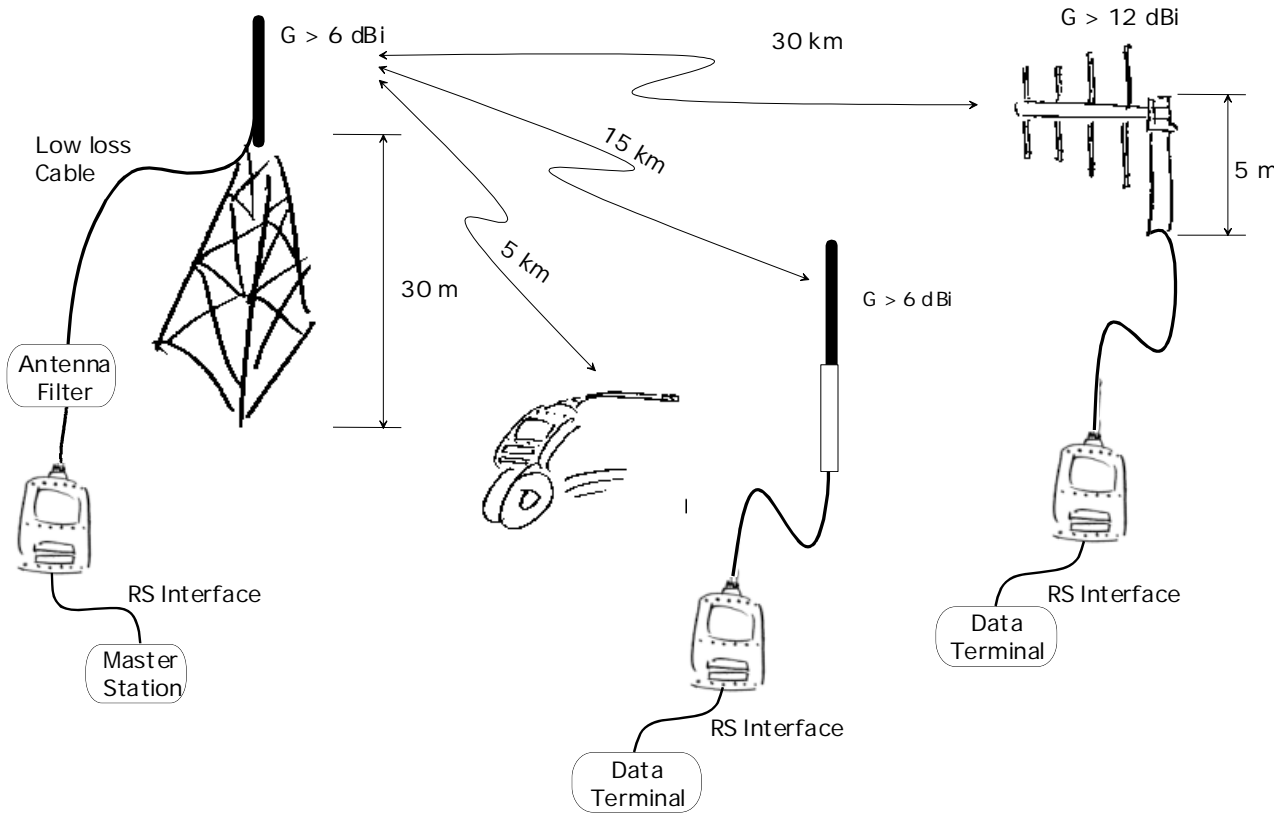

## 11 DESIGNING SYSTEMS

### 11.1 Factors affecting the quality and distance of the radio connection

- power of the radio transmitter
- sensitivity of the radio receiver
- tolerance of spurious radiation's of the radio modulating signal
- amplification of transmitting and receiving antennas
- antenna cable attenuation
- antenna height
- natural obstacles
- interference caused by other electrical equipment

The transmitter power of the base model of SATELLINE-3AS is 1 W (maximum) and the sensitivity of the receiver better than -115 dBm. Thus in a flat area and in free space with a 1/4 wave antenna (antenna amplification 1dBi) and antenna height of 1 m communication distances of 3 to 4 km can be achieved. Distances may be considerably shorter in situations where there are metallic walls or other material inhibiting the propagation of radio waves.

Over long distances, increasing the height of antennas can often solve problems caused by natural obstacles. A ten-fold increase in distance can be achieved with the use of amplifying antennas. Frequent topographical variations over long distances may require that at least one of the antennas be raised to a height of 10 to 20 m.

If the antenna cable is more than 10 meters long it is necessary to use a low loss cable ( $< 0.7$  dB /10 m) in order not to waste the antenna amplification. Adding a repeater station can also solve problematical radio connections. In systems with many base stations the RSSI-signal can be used to assist in choosing the base station with the best signal. A communications network can also be built with a combination of cables and radio data modems.

The SATELLINE-3AS radio data modem operates in the 450 MHz band, where man made interference is insignificant. Long distance interference needs not to be taken into account even in special weather conditions.

The SATELLINE-3AS tolerates normal levels of interference that occur. However, exceptionally high levels of interference can break through the safeguards and thus cause errors in data transfer. In mobile vehicle applications the range of operation can be increased by dividing the transmitted data into e.g. 50...500 byte long blocks and by re-transmitting the defected blocks.

A sufficient safety margin can be obtained by testing the communication path using extra 6 dB attenuation at the antenna connection and with slightly less effective antennas than those to be used in the final system.

## **11.2 Radio field strength**

Radio signal strength must be good enough for successful data transfer. Where field strength is above a certain level, the operational results are very good. Below this level, a few dB marginal areas occur in which errors begin to be generated by noise and interference that will eventually lead to loss of connection.

The field strength is at its optimum level in open space, although increasing distance will still reduce it. It must also be remembered that one open space has different environmental and external factors to another, and that the effects on transmission quality must be taken into account when planning the system.

Ground, ground contours and buildings cause attenuation (loss of energy through absorption) and reflection of radio waves. Buildings reflect radio waves and therefore the affects of attenuation are not as acute when transmission is over a short distance.

However, the reflected waves will often be a bit delayed, and when they combine with the direct radio waves they interact in either a weakening or a strengthening way. This causes the fading effect in mobile systems. In reality very sharp signal drops spaced about 35 cm apart may occur. The attenuation may even reach 40 dB, normally less.

## **11.3 Remarks concerning the 869 MHz frequency band**

According to a recommendation of ETSI, the frequencies range 869.4...869.65 MHz is reserved for use of license free radio appliances. The application of this recommendation varies in each country, and for this reason local regulations concerning this frequency range must always be checked.

In frequency range 869.4...869.65 MHz, the maximum allowed radiated power of an antenna is 500 mW ERP (+27dBm). When calculating the power, antenna cable attenuation and antenna gain must be taken into account. For example, if the gain of the antenna is 10 dBd and the attenuation of the antenna cable used is -3dB, the maximum allowed transmission power is 100 mW (+20 dBm). It should be noted that by increasing the gain of the antennas, connection distance could be increased. This is due to the fact that the output power of the transmission remains constant, but the added antenna gain of the receiving end will enable reception of weaker signals than otherwise possible.

System designers must also take into account that at the frequency range of 869.4...869.65 MHz the transmitter is allowed to be ON only 10% of the time. Whether this limit is exceeded or not, depends on the protocol used. At a frequency range of 869 MHz there are in addition to the frequency channel 869.4...869.65 MHz also other ranges, but at these ranges the maximum allowed radiated power is 25 mW and the transmitter is allowed to be ON only 1 % or 0.1 % of the time.

## 12 CHECK LIST

The following points must be taken into account when installing and configuring a radio modem:

1. All operating voltages of all the equipment concerned must always be switched OFF before connecting the serial interface cable.
2. When considering the exact placement of a radio modem and/or its antenna, the following points must be taken into account to guarantee optimal results:
  1. The antenna should be installed in open space as far as possible from any possible sources of interference
  2. The radio modem should not be installed onto a strongly vibrating surface
  3. The radio modem should be installed in such a way as to minimise exposure to direct sunlight or excessive humidity.
3. To ensure reliable operation the voltage output of the power supply used must be stable enough and the current capability of the power supply must be sufficient.
4. The antenna must be installed according to instructions.
5. *Serial interface settings between the radio modem and the terminal unit must correspond to each other.*
6. All radio modems in the same system must be configured using same settings (radio frequency, channel spacing and data field length). See Chapter 5.1.

## 13 ACCESSORIES

### 13.1 RS-232 cables and adapters

| Type       | Description                             | Length | Note                                                       |
|------------|-----------------------------------------|--------|------------------------------------------------------------|
| NARS-1F    | Interface adapter D15 m / D9 f, 1A fuse | -      | including 2 m power supply cables a and programming switch |
| NARS-1F-4A | As NARS-1F with 4A fuse for Epic only   |        |                                                            |
| CRS-9      | Interface cable D9 m / D9 f             | 2 m    | -                                                          |
| CRS-1M     | Interface cable D15 m / D25 m           | 2 m    | including power supply cables                              |
| CRS-1F     | Interface cable D15 m / D25 f           | 2 m    | including power supply cables                              |
| CRS-2M     | Interface cable D15 m / D9 m            | 2 m    | including power supply cables                              |
| CRS-2F     | Interface cable D15 m / D9 f            | 2 m    | including power supply cables                              |

Note! In the description, m=male, f=female connector type.

### 13.2 RS-485/422 cables and adapters

| Type      | Description                                        | Length | Note                                            |
|-----------|----------------------------------------------------|--------|-------------------------------------------------|
| NARS-2    | Interface adapter D15 m / screw terminals, 1A fuse | -      | Screw terminals for RS-485/422 and power supply |
| NARS-2-4A | As NARS-2 with 4A fuse for Epic only               | -      |                                                 |
| CRS-PB    | Interface cable D15 m / D9 m                       | 2 m    | including power supply cables                   |

### 13.3 RF-cables

| Type      | Description                                | Length | Note             |
|-----------|--------------------------------------------|--------|------------------|
| CRF-1     | Cable with TNC m/TNC f-connectors          | 1 m    | RG58 (3 dB/10 m) |
| CRF-5F    | Cable with TNC m/TNC f-connectors          | 5 m    | RG58 (3 dB/10 m) |
| CRF-5M    | Cable with TNC m/TNC m-connectors          | 5 m    | RG58 (3 dB/10 m) |
| CRF-15    | Cable with TNC f/TNC f 90-degree connector | 15 cm  | RG58 (3 dB/10 m) |
| RG213     | Low loss cable                             | X      | 1.6 dB/10 m      |
| ECOFLEX10 | Low loss cable                             | X      | 0.9 dB/10 m      |
| AIRCOM+   | Low loss cable                             | X      | 0.8 dB/10 m      |
| ECOFLEX15 | Low loss cable                             | X      | 0.6 dB/10 m      |

Note! In the description, m=male, f=female connector type.

## 13.4 Antennas

| Type             | Description                                     |
|------------------|-------------------------------------------------|
| GAINFLEX 400-430 | Half-wave antenna                               |
| GAINFLEX 430-470 | Half-wave antenna                               |
| CA420Q           | Sleeve fed quarter wave whip, 2dBi, 405–440 MHz |
| CA450Q           | Sleeve fed quarter wave whip, 2dBi, 440-475 MHz |
| MINIFLEX 400-430 | Helix antenna                                   |
| MINIFLEX 430-470 | Helix antenna                                   |
| ANTENNA 869      | Quarter wave antenna for 869 MHz modems         |

SATEL antenna selection includes also directional and/or omni-directional antenna. These can be supplied separately on request. Antennas are also available for the 869 MHz frequency range.

## 13.5 Filters and lightning protectors

If a radio modem system is installed in an environment that contains high-power transmitters or sources of radio frequency interference, it is highly recommendable to insert suitable filters between each radio modem and its antenna. If a station is installed to a location exposed to lightning, it is recommended to insert a lightning protector to the feed-line outside the protected zone. SATEL Technical Support can give guidance in the selection of suitable products.

## 13.6 Power supplies

| Type     | Description                                          |
|----------|------------------------------------------------------|
| PS-DIN-2 | 100 - 240 Vac/24 Vdc/2.5A, to be mounted to DIN rail |

## 13.7 Battery pack

| Type      | Description                                        |
|-----------|----------------------------------------------------|
| SATEL-321 | Weather proof battery pack with extended life time |

## 13.8 Installation and enclosures

| Type       | Description                                                |
|------------|------------------------------------------------------------|
| I-DIN      | Installation plate for DIN rail mounting for 3AS(d) modems |
| I-DIN Epic | Installation plate for DIN rail mounting for Epic          |
| H-WP       | Weather proof housing (IP43) for 3AS(d) modems             |
| H-WPm2     | Weather proof housing (IP53)                               |
| H-WP-X2    | Weather proof housing (IP43) for Epic modems               |

## 14 APPENDIX A

| ASCII CHARACTER TABLE |    |     |    |    |   |     |    |   |     |    |   |     |    |   |     |    |   |
|-----------------------|----|-----|----|----|---|-----|----|---|-----|----|---|-----|----|---|-----|----|---|
| D                     | H  | A   | D  | H  | A | D   | H  | A | D   | H  | A | D   | H  | A | D   | H  | A |
| 0                     | 0  | NUL | 43 | 2B | + | 86  | 56 | V | 129 | 81 |   | 172 | AC |   | 215 | D7 |   |
| 1                     | 1  | SOH | 44 | 2C | , | 87  | 57 | W | 130 | 82 |   | 173 | AD |   | 216 | D8 |   |
| 2                     | 2  | STX | 45 | 2D | - | 88  | 58 | X | 131 | 83 |   | 174 | AE |   | 217 | D9 |   |
| 3                     | 3  | ETX | 46 | 2E | . | 89  | 59 | Y | 132 | 84 |   | 175 | AF |   | 218 | DA |   |
| 4                     | 4  | EOT | 47 | 2F | / | 90  | 5A | Z | 133 | 85 |   | 176 | B0 |   | 219 | DB |   |
| 5                     | 5  | ENQ | 48 | 30 | 0 | 91  | 5B | [ | 134 | 86 |   | 177 | B1 |   | 220 | DC |   |
| 6                     | 6  | ACK | 49 | 31 | 1 | 92  | 5C | \ | 135 | 87 |   | 178 | B2 |   | 221 | DD |   |
| 7                     | 7  | BEL | 50 | 32 | 2 | 93  | 5D | ] | 136 | 88 |   | 179 | B3 |   | 222 | DE |   |
| 8                     | 8  | BS  | 51 | 33 | 3 | 94  | 5E | ^ | 137 | 89 |   | 180 | B4 |   | 223 | DF |   |
| 9                     | 9  | HT  | 52 | 34 | 4 | 95  | 5F | _ | 138 | 8A |   | 181 | B5 |   | 224 | E0 |   |
| 10                    | A  | LF  | 53 | 35 | 5 | 96  | 60 | ` | 139 | 8B |   | 182 | B6 |   | 225 | E1 |   |
| 11                    | B  | VT  | 54 | 36 | 6 | 97  | 61 | a | 140 | 8C |   | 183 | B7 |   | 226 | E2 |   |
| 12                    | C  | FF  | 55 | 37 | 7 | 98  | 62 | b | 141 | 8D |   | 184 | B8 |   | 227 | E3 |   |
| 13                    | D  | CR  | 56 | 38 | 8 | 99  | 63 | c | 142 | 8E |   | 185 | B9 |   | 228 | E4 |   |
| 14                    | E  | SO  | 57 | 39 | 9 | 100 | 64 | d | 143 | 8F |   | 186 | BA |   | 229 | E5 |   |
| 15                    | F  | SI  | 58 | 3A | : | 101 | 65 | e | 144 | 90 |   | 187 | BB |   | 230 | E6 |   |
| 16                    | 10 | DLE | 59 | 3B | ; | 102 | 66 | f | 145 | 91 |   | 188 | BC |   | 231 | E7 |   |
| 17                    | 11 | DC1 | 60 | 3C | < | 103 | 67 | g | 146 | 92 |   | 189 | BD |   | 232 | E8 |   |
| 18                    | 12 | DC2 | 61 | 3D | = | 104 | 68 | h | 147 | 93 |   | 190 | BE |   | 233 | E9 |   |
| 19                    | 13 | DC3 | 62 | 3E | > | 105 | 69 | i | 148 | 94 |   | 191 | BF |   | 234 | EA |   |
| 20                    | 14 | DC4 | 63 | 3F | ? | 106 | 6A | j | 149 | 95 |   | 192 | C0 |   | 235 | EB |   |
| 21                    | 15 | NAK | 64 | 40 | @ | 107 | 6B | k | 150 | 96 |   | 193 | C1 |   | 236 | EC |   |
| 22                    | 16 | SYN | 65 | 41 | A | 108 | 6C | l | 151 | 97 |   | 194 | C2 |   | 237 | ED |   |
| 23                    | 17 | ETB | 66 | 42 | B | 109 | 6D | m | 152 | 98 |   | 195 | C3 |   | 238 | EE |   |
| 24                    | 18 | CAN | 67 | 43 | C | 110 | 6E | n | 153 | 99 |   | 196 | C4 |   | 239 | EF |   |
| 25                    | 19 | EM  | 68 | 44 | D | 111 | 6F | o | 154 | 9A |   | 197 | C5 |   | 240 | FO |   |
| 26                    | 1A | SUB | 69 | 45 | E | 112 | 70 | p | 155 | 9B |   | 198 | C6 |   | 241 | F1 |   |
| 27                    | 1B | ESC | 70 | 46 | F | 113 | 71 | q | 156 | 9C |   | 199 | C7 |   | 242 | F2 |   |
| 28                    | 1C | FS  | 71 | 47 | G | 114 | 72 | r | 157 | 9D |   | 200 | C8 |   | 243 | F3 |   |
| 29                    | 1D | GS  | 72 | 48 | H | 115 | 73 | s | 158 | 9E |   | 201 | C9 |   | 244 | F4 |   |
| 30                    | 1E | RS  | 73 | 49 | I | 116 | 74 | t | 159 | 9F |   | 202 | CA |   | 245 | F5 |   |
| 31                    | 1F | US  | 74 | 4A | J | 117 | 75 | u | 160 | A0 |   | 203 | CB |   | 246 | F6 |   |
| 32                    | 20 | SP  | 75 | 4B | K | 118 | 76 | v | 161 | A1 |   | 204 | CC |   | 247 | F7 |   |
| 33                    | 21 | !   | 76 | 4C | L | 119 | 77 | w | 162 | A2 |   | 205 | CD |   | 248 | F8 |   |
| 34                    | 22 | "   | 77 | 4D | M | 120 | 78 | x | 163 | A3 |   | 206 | CE |   | 249 | F9 |   |
| 35                    | 23 | #   | 78 | 4E | N | 121 | 79 | y | 164 | A4 |   | 207 | CF |   | 250 | FA |   |
| 36                    | 24 | \$  | 79 | 4F | O | 122 | 7A | z | 165 | A5 |   | 208 | D0 |   | 251 | FB |   |
| 37                    | 25 | %   | 80 | 50 | P | 123 | 7B | { | 166 | A6 |   | 209 | D1 |   | 252 | FC |   |
| 38                    | 26 | &   | 81 | 51 | Q | 124 | 7C |   | 167 | A7 |   | 210 | D2 |   | 253 | FD |   |
| 39                    | 27 | '   | 82 | 52 | R | 125 | 7D | } | 168 | A8 |   | 211 | D3 |   | 254 | FE |   |
| 40                    | 28 | (   | 83 | 53 | S | 126 | 7E | ~ | 169 | A9 |   | 212 | D4 |   | 255 | FF |   |
| 41                    | 29 | )   | 84 | 54 | T | 127 | 7F |   | 170 | AA |   | 213 | D5 |   |     |    |   |
| 42                    | 2A | *   | 85 | 55 | U | 128 | 80 |   | 171 | AB |   | 214 | D6 |   |     |    |   |

## 15 APPENDIX B

### 15.1 Functional delays

| Function                                                    | Delay (ms)          |
|-------------------------------------------------------------|---------------------|
| Wakeup time from STAND-BY to ON<br>(controlled by DTR line) | 200                 |
| Serial interface, turnaround time of RS-232                 | 0                   |
| Serial interface, turnaround time of RS-485                 | < 1                 |
| Intercharacter delay                                        | max. 2-3 characters |
| SL-Ping response time from remote modem                     | 129                 |

SL-Ping response time (typical) in Source Routing network:

$t =$  SL-Ping response time from router

router.count = Count routers from master to router/slave to ping

Response time from router/slave =  $(t * (\text{router.count} + 1)) + 1 \text{ ms}$

Example Response time from slave behind two routers

$(129 \text{ ms} * (2 + 1)) + 1 \text{ ms} = 388 \text{ ms}$

### 15.2 Transmission related delays

Delay from the end of transmission to the end of reception on the serial interface:

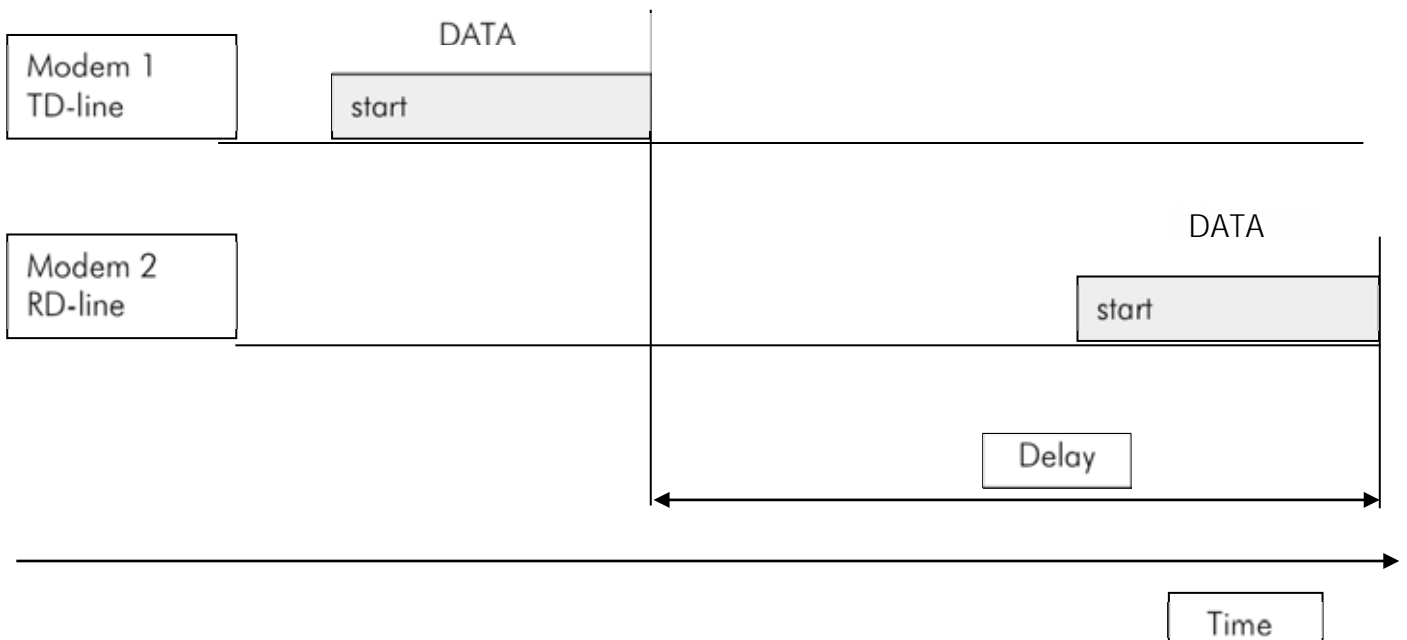

### 15.2.1 Transmission delays when using a 12.5 kHz radio channel

Transmission delays (ms) without FEC-function (Forward Error Correction).

Number of bytes sent

| Bps   | 1  | 10 | 100 | 500 |
|-------|----|----|-----|-----|
| 1200  | 38 | 38 | 38  | 38  |
| 4800  | 33 | 32 | 32  | 32  |
| 9600  | 31 | 31 | 31  | 31  |
| 19200 | 31 | 33 | 65  | 195 |
| 38400 | 31 | 36 | 88  | 322 |

Delays are in milliseconds and with a 10% margin.

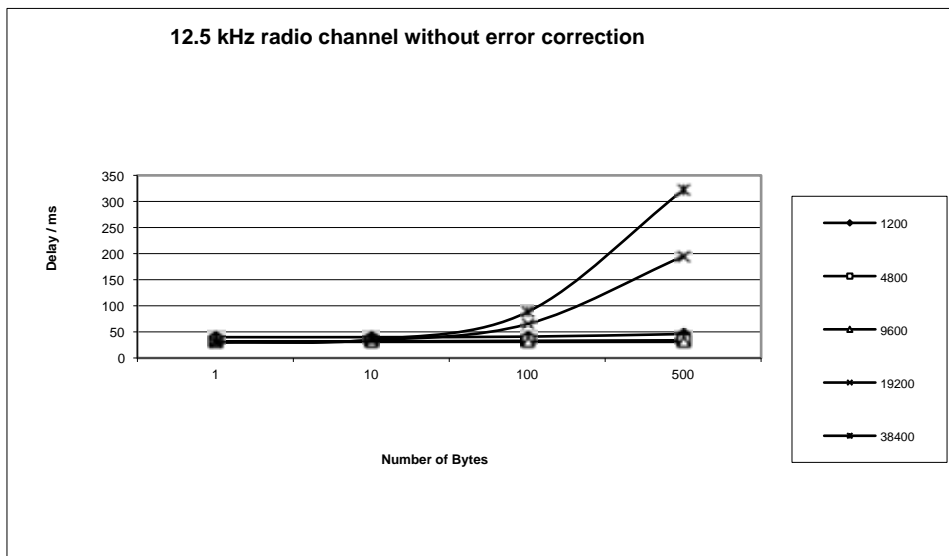

Transmission delays with FEC-function (Forward Error Correction).

Number of bytes sent

| Bps   | 1  | 10 | 100 | 500 |
|-------|----|----|-----|-----|
| 1200  | 50 | 50 | 51  | 50  |
| 4800  | 44 | 44 | 44  | 44  |
| 9600  | 43 | 43 | 66  | 126 |
| 19200 | 43 | 42 | 104 | 364 |
| 38400 | 47 | 46 | 132 | 496 |

Delays are in milliseconds and with a 10% margin.

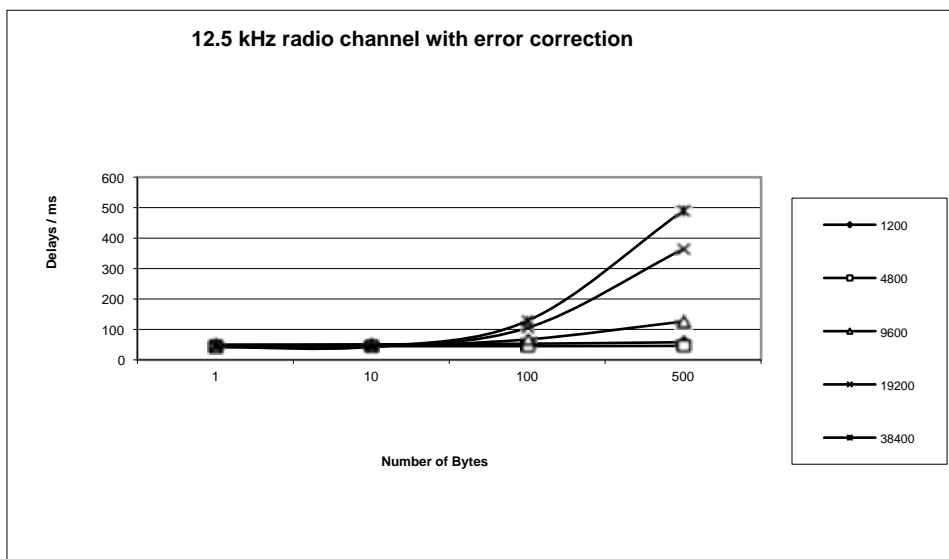

### 15.2.2 Transmission delays using a 25 kHz radio channel

Transmission delays without FEC-function (Forward Error Correction).

Number of bytes sent

| Bps   | 1  | 10 | 100 | 500 |
|-------|----|----|-----|-----|
| 1200  | 28 | 28 | 28  | 28  |
| 4800  | 22 | 22 | 22  | 22  |
| 9600  | 21 | 21 | 21  | 21  |
| 19200 | 23 | 23 | 22  | 23  |
| 38400 | 25 | 23 | 36  | 101 |

Delays are in milliseconds and with a 10% marginal.

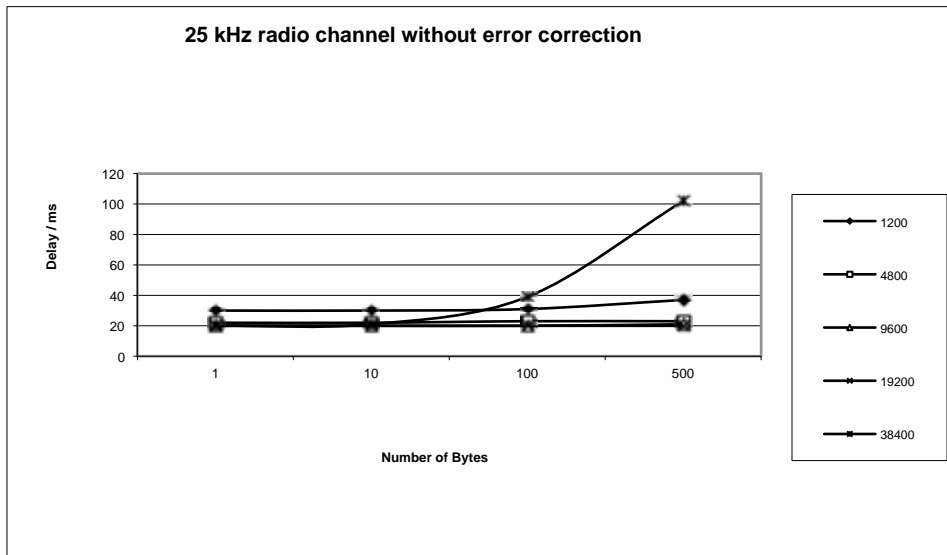

Transmission delays with FEC-function (Forward Error Correction).

Number of bytes sent

| Bps   | 1  | 10 | 100 | 500 |
|-------|----|----|-----|-----|
| 1200  | 34 | 34 | 34  | 34  |
| 4800  | 28 | 28 | 28  | 28  |
| 9600  | 27 | 32 | 28  | 31  |
| 19200 | 35 | 31 | 35  | 64  |
| 38400 | 33 | 33 | 57  | 185 |

Delays are in milliseconds and with a 10% margin.

